

Awenta **PRO**

Operation and Installation Manual

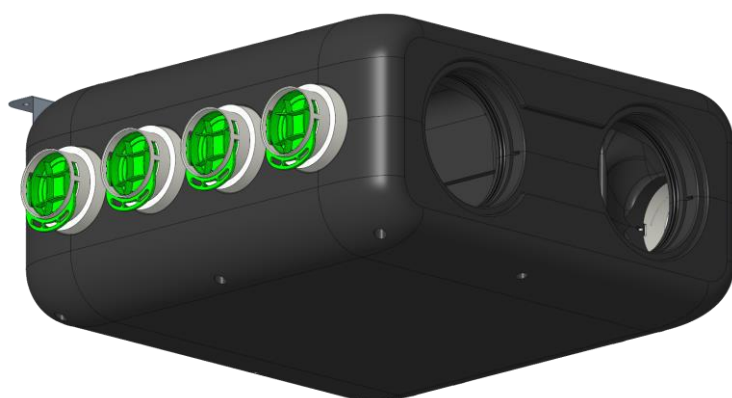

Air handling unit with heat recovery + duct distributor VARR75-160 AQUILA 305

*Air handling unit equipped with Aero 4A ver.2 ventilation controller with NANO COLOR 2 ver.1 control panel
Applies to models: VARP305L/02 VARP305P/02 (suspended/ceiling installation)*

TABLE OF CONTENTS

1. OPERATOR'S MANUAL

1.1. IMPORTANT INFORMATION/SAFETY INSTRUCTIONS 4

1.2. INTENDED USE 5

1.3. TRANSPORT AND STORAGE 5

1.4. SAFETY MEASURES REGARDING OPERATING OF THE UNIT 5

1.5. TECHNICAL SPECIFICATION 6

1.6. TECHNICAL DRAWINGS 6

1.7. BASIC COMPONENTS OF THE UNIT 7

1.8. LAYOUT OF CONNECTIONS 8

1.9. OPERATION PRINCIPLE 9

1.10. ITEMS OF EQUIPMENT 9

1.11. INSTALLING AND PREPARING THE UNIT FOR OPERATION 9

1.12. MAINTENANCE..... 12

1.13. PRE-HEATER / SECONDARY HEATER 13

1.14. WASTE MANAGEMENT NOTICE 14

2. NANO COLOR CONTROL PANEL

2.1. OPERATION PRINCIPLE 15

2.2. INSTALLATION 15

2.3. DESCRIPTION OF THE MAIN SCREEN 16

2.4. OPERATION MODE 18

2.5. SETTINGS..... 19

2.6. TEMPERATURE SETTINGS..... 20

2.7. THERMOSTAT INFO 20

2.8. VENTILATION INFORMATION SCREEN 20

2.9. FIREPLACE MODE 21

2.10. CHANGING THE SYSTEM OPERATION MODE 21

2.11. SENSORS 23

2.12. VEX4 MODULE 24

2.13. SMART MODE 25

2.14. FOULED FILTER INDICATION 26

2.15. MAIN MENU..... 26

2.16. SCHEDULE SETTINGS..... 27

2.17. SERVICE MENU..... 27

2.17.1. IN-OUT 28

2.17.2. DISTRIBUTOR 28

2.17.3. NANO 29

2.17.4. VENTILATION..... 30

2.17.5. SENSORS 32

3. NANO WIRELESS NETWORK34

4. MODBUS RTU PROTOCOL CONFIGURATION34

5. VLAN iNEXT INTERNET MODULE34

6. WIRING DIAGRAMS

6.1. ELECTRICAL DIAGRAM OF THE AERO 4 CONTROLLER – version for operation diagram 1. Standard 35

6.2. CONNECTING THE NANO COLOR CONTROL PANEL 36

6.3. CONNECTING THE NANO COLOR CONTROL PANEL WITH C14 - VRS NETWORK CONVERTERS 36

6.4. CONNECTING THE NANO COLOR CONTROL PANEL WITH THE iNEXT VLAN INTERNET MODULE 36

6.5. CONNECTING THE NANO COLOR CONTROL PANEL WITH VACS-1 or VSPM AIR QUALITY SENSOR..... 37

6.6. CONNECTING THE NANO COLOR CONTROL PANEL WITH THE VSHC or VSHW SENSOR..... 37

6.7. CONNECTING THE NANO COLOR CONTROL PANEL WITH VSHC or VSHW and VACS-1 or VSPM SENSORS 37

6.8. CONNECTION OF A PREHEATER AND SECONDARY HEATER 38

7. ATTACHMENTS

7.1. PRODUCT DATA SHEETS/ENERGY LABELS 38

1. OPERATOR'S MANUAL

1. 1. IMPORTANT INFORMATION

Read the Operator's Manual carefully before installation or any other activity related to work with the unit! AWENTA takes not responsibility for any damage resulting from incorrect operation, non-intended use or unauthorised repairs or modifications of the product.

This installation manual is an essential part of the product and contains important technical information and instructions regarding the occupational safety. Carefully read the operation and installation manual and keep it available in a readily accessible place for future reference. The manual is also available at www.awentapro.pl

Safety precautions:

- This product can be used by children at least 8 years old, by people with impaired physical and/or mental abilities, and by people without any experience in or understanding of the operation of the product, if supervised or instructed by a competent adult in the safe use of the product so that they understand the relevant operating risks. This product is not a toy and children should not play with it. Children should not be allowed to clean or maintain the product without supervision of an adult.
- The unit is intended for indoor electrical installation provided with means or devices having contact breaks at all poles, ensuring complete isolation under category III overvoltage conditions in accordance with the regulations for such installation. The device should be connected directly to an earthed 230 VAC mains socket.
- When installing and using the unit, it is mandatory to observe the provisions specified in this manual and all the applicable local and national building, electrical and technical standards.
- It is imperative to read all warnings in this manual and become familiar with the warning signs located on the air handling unit, as they contain information for your safety.
- Failure to follow the instructions and warnings contained in this manual may result in personal injury and damage to the unit.
- If the unit is handed over/sold etc. to another user, this manual must also be handed over.
- Assembly and repairs of the unit may only be carried out after it has been effectively disconnected from the power network.
- It is forbidden to operate the unit beyond the temperature range specified in the user manual, as well as in aggressive and potentially explosive environments.
- Do not place heating or other devices near the power supply cable of the unit.
- It is forbidden to connect the device to the mains if the power cord is found damaged.
- If the inseparable power cord is damaged it should be replaced by the manufacturer, a serviceman or by a qualified person in order to avoid hazards.
- The OHS rules must be observed, when using electrical equipment during the assembly of the unit.
- Exercise care, when unpacking/unloading of the unit.
- Do not bend the power cord, avoid damaging it.
- Use the air handling unit only for its intended purpose.

1.2. INTENDED USE

The unit is equipped with a cross-flow plate heat exchanger, electric heater (sold separately) and is designed to save thermal energy by its recuperation, being one of the elements used in energy-saving technology systems. The unit is considered a supplementary device and must not be used as a stand-alone, independent heating source.

The unit is intended for securing continuous air exchange by means of forced ventilation in houses, offices, hotels, cafés and other residential and public premises, as well as for recuperation of heat energy from discharged air to heat up clean air coming from the outside. External air is heated by transferring heat energy from the exhaust air stream via a heat exchanger. The unit is not intended for industrial use.

Air flowing through the unit must not contain volatile flammable or explosive substances, chemically active vapours, dust with large particles, soot, fats or media conducive to the formation of harmful substances (toxic substances, dust, pathogenic microorganisms), sticky substances and fibrous materials.

The unit is designed for installation in a closed building, in the ambient air temperature from 0°C to +40°C, the relative humidity of up to 90%.



WARNING! In the event of extremely unfavorable weather conditions (outside temperature below -10°C), it is not recommended to use the air handling unit above 70% air flow. This may result in excessive cooling of the room and incorrect operation of the device.

1.3. TRANSPORT AND STORAGE

Permissible storage and transport temperatures range from -20 to +50°C.

Transport and unpack the unit with care. Dispose of the packaging in an environmentally friendly manner.

1.4. SAFETY MEASURES REGARDING OPERATING OF THE UNIT

- Always and absolutely observe the safety regulations, warnings, comments, and cautions as recommended herein. Failure to observe the safety regulations, warnings, and cautions and instructions in this document may result in personal injury or damage.
- Do not touch the control panel or the electric feeder box with wet hands.
- It is forbidden to operate the unit with wet hands.
- The use of a high-pressure washer or water jet to clean the control panel is prohibited.
- Avoid any contact between the electric parts of the unit with water.
- It is not allowed to block the inlets and outlets of air conduits, when the unit is in operation.
- Maintenance of the unit may only be carried out, after it has been effectively disconnected from the power network.
- It is forbidden to place on the power supply cord any objects which could abrade, cut or damage it otherwise.
- It is forbidden to store explosive or flammable substances in the vicinity of the unit.
- It is forbidden to open the unit, when it is in operation.
- In case of unusual noise, odour and smoke, immediately turn the control panel off and contact the service centre or the manufacturer.
- The installation of the unit should always be carried out in compliance with the general and local construction, safety and installation regulations issued by the relevant official institutions and the energy and water supply companies.
- The unit should be connected to the ventilation system before commissioning. Ventilation ducts provide protection from access to rotating fan blades. The ducts shall be secured against slipping off its connections in a manner requiring the use of tools.

1.5. TECHNICAL SPECIFICATION

Specifications:	AQUILA 305 (ceiling)
Supply voltage	230 V AC / 50Hz
Maximum power consumption	210 W
Preheater power consumption	750 W
Electrical protection class	I
IP protection class	IP22
Capacity (at 100 Pa)	313 m ³ /h
Max motor speed	4000 rpm
Noise level	49 dB(A)
Max. heat recovery efficiency	up to 95%
Heat exchanger material	Polystyrene
Housing material	EPP + powder coated steel
Filter – intake vent	M5 ISO ePM10 (optional F7 ISO ePM1)
Filter – exhaust	M5 ISO ePM10
Pre-filter intake/exhaust	VFWAR (optional)
Diameter of air connector	160 mm
Diameter of the condensate drain pipe	32 mm
Mounting position	Horizontal (suspended/ceiling)
Weight	16kg (VAR305) + 5kg (VARR75-160)
Controller type	AERO 4 + NANO COLOR
Dimensions [height x width x depth]	625 mm x 1042 mm x 322 mm
Dimensions VARR75-160 [height x width x depth]	693 mm x 1623,5 mm x 322 mm
By-pass	Automatic (100% by-pass)
Fans	2x radial fan with EC motor
Modbus RTU communication	YES
Internet module	VLAN iNEXT (optional)
Air quality sensor	VACS-1 (optional)
CO ₂ concentration and humidity sensor	VSHC (optional)
Humidity sensor	VSHW (optional)

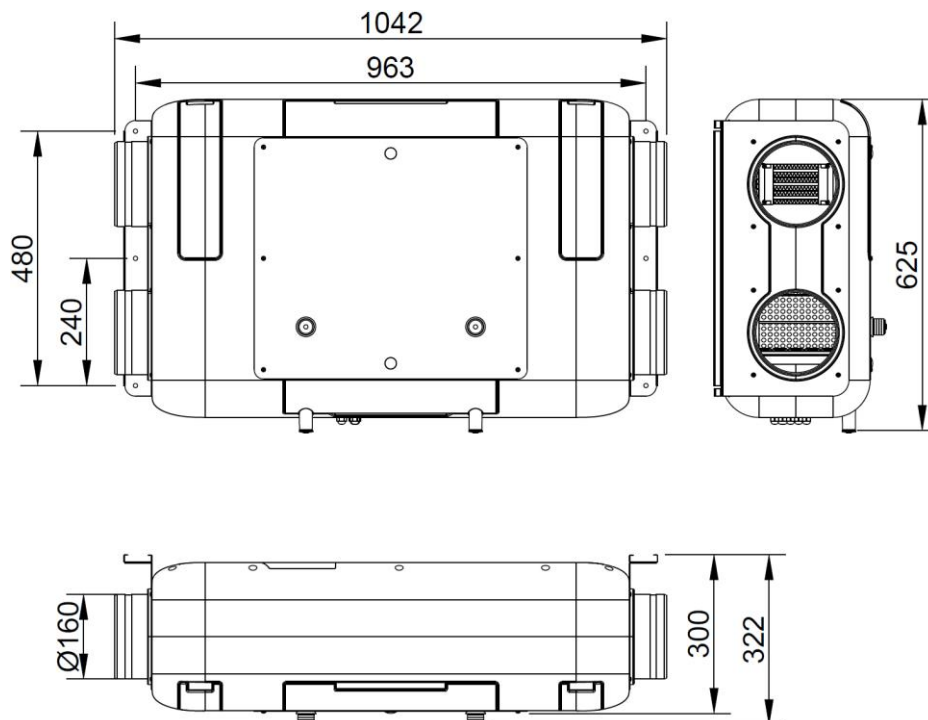
1.6. TECHNICAL DRAWINGS
VARP305

VARP305 + VARR75-160

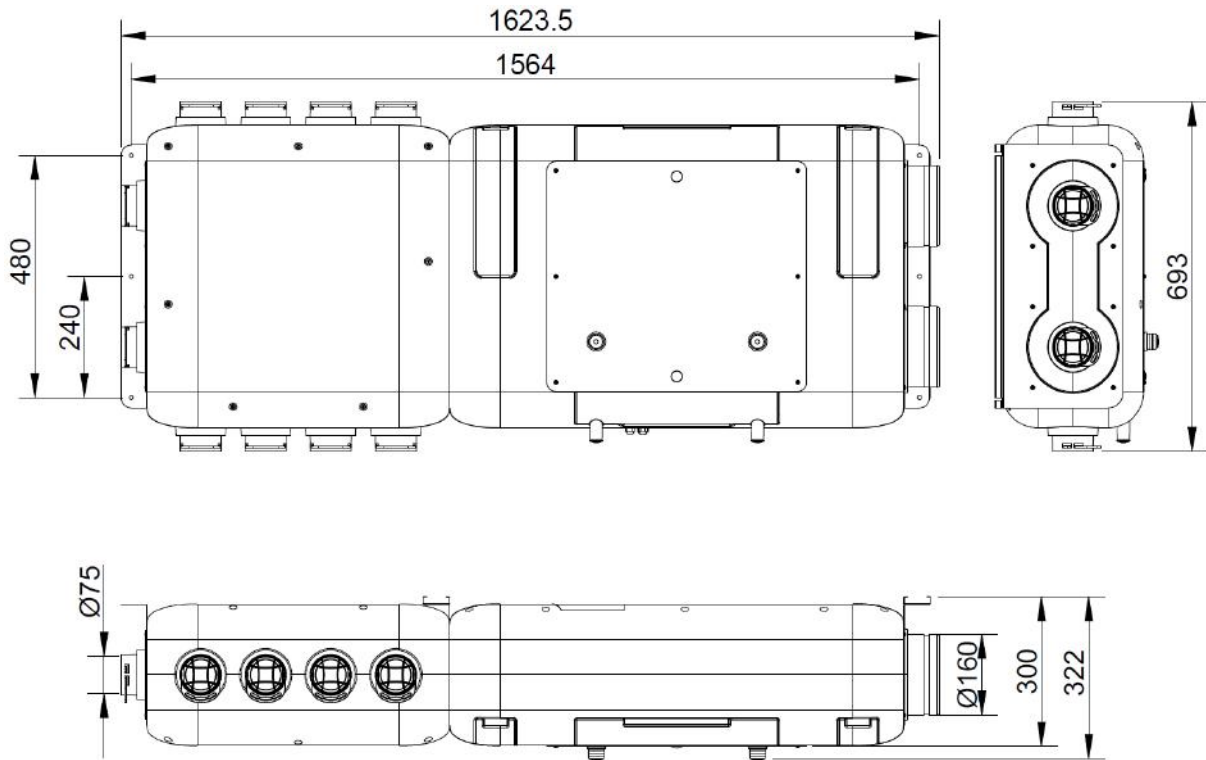

1.7. BASIC COMPONENTS OF THE UNIT

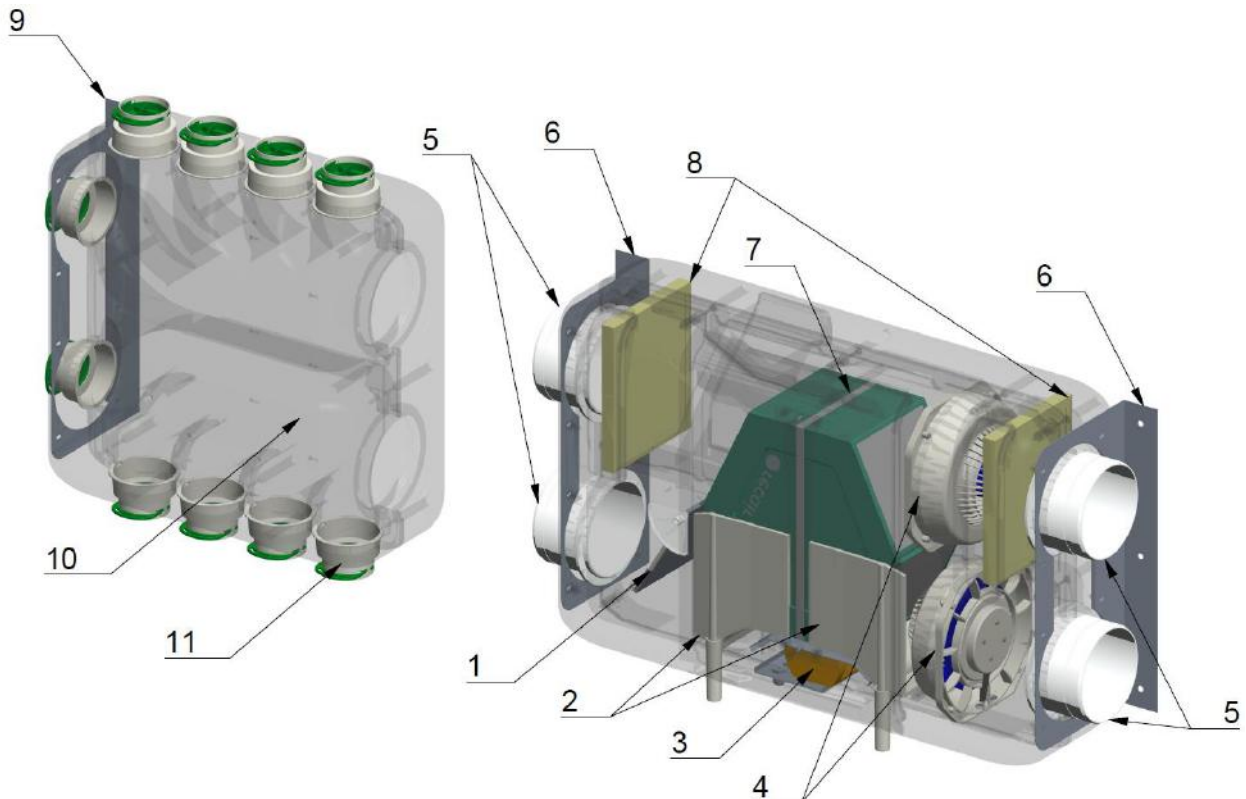

- | | |
|--|--------------------------------------|
| 1. By-pass damper | 7. Counter-flow heat exchanger |
| 2. Drip trays | 8. Air filters |
| 3. Controller | 9. Air distributor mounting brackets |
| 4. Fans | 10. Air distributor |
| 5. Connection pipes Ø160 | 11. Connection pipes Ø75 |
| 6. Air handling unit mounting brackets | |

1.8. LAYOUT OF CONNECTIONS – LEFT /RIGHT VERSIONS

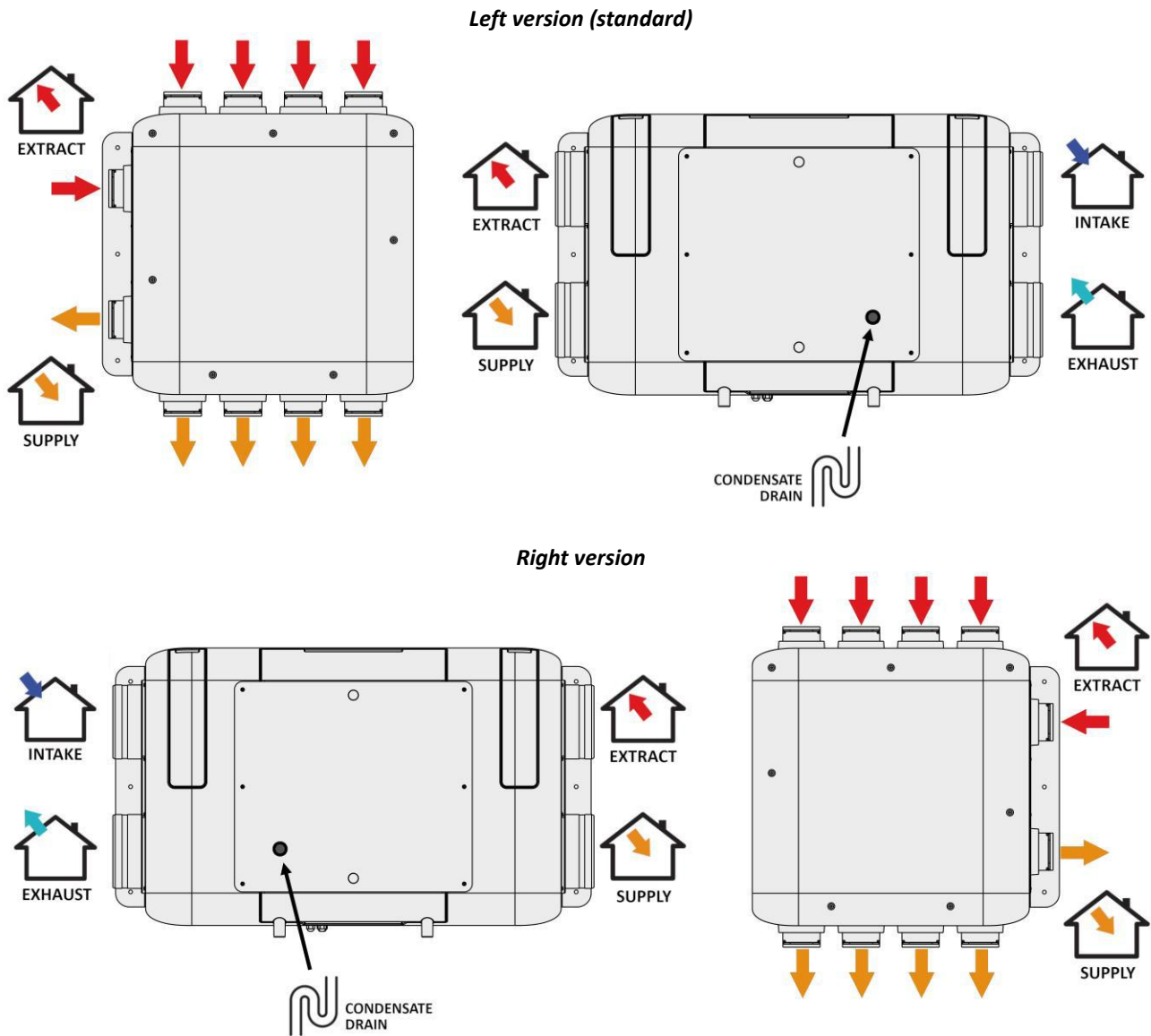

Connection ports designation:



INTAKE – outdoor air intake duct



EXHAUST – used air exhaust duct



EXTRACT – duct removing used air from rooms



SUPPLY – duct supplying air to rooms

1.9. OPERATION PRINCIPLE

Fresh air is drawn in with the air intake located outside the building. Then, using ventilation ducts, the air is transported to the air handling unit. After filtering, it flows to the heat exchanger where heat energy exchange from the exhaust stream takes place. The air is heated in winter and cooled in the summer. Next, the supplied air flows to the so-called “clean” areas such as a living room or bedroom.

Both, used and polluted air is extracted from the so-called “dirty” areas such as a toilet, bathroom, kitchen or laundry by means of exhaust grilles or diffusers, and then directed to the air handling unit by means of exhaust ducts. After filtering, it flows to the heat exchanger, where the heat or cold is “recovered” from the used air. The air is then moved to an outlet located outside the building.

1.10. ITEMS OF EQUIPMENT

The standard accessories of the unit include the following:

- Cross-flow plate heat exchanger.
- M5 class supply and exhaust air filters.
- EC fans: centrifugal supply and extract fans with electrically commutated motors.
- NANO COLOR remote control panel which is connected, with a communication cable, to the control system, located inside the electric compartment of the air handling unit.
- Flexible condensate drain pipe f32
- Spacer profile (for ceiling mounting)

CAUTION: Some of the units come with the dedicated VARR75-160 air distribution Box.

1.11. INSTALLING AND PREPARING THE UNIT FOR OPERATION

Installation of the air handling unit

- The air handling unit should be installed in a horizontal position. The device can be attached to the ceiling using the mounting brackets that are part of the device.

● CEILING MOUNTING

- The unit must be fixed to the ceiling allowing at least 500 mm length from the wall which is required to provide space for the air ducts if the VARR75-160 distribution box is installed.

CAUTION: The ceiling to which the air handling unit will be fixed must not be permeable to water. It should effectively protect the unit from flooding even if the building's plumbing system fails.

- Check whether the mounting structure can support the weight of the unit. If not, use additional beams to reinforce the location intended for installation. The unit must be installed on a rigid and stable surface.
- To securely fix the air handling unit and distribution box on the mounting brackets, use dowels or other fasteners suitable for the type of load bearing material. After fixing the unit, check it for stability.

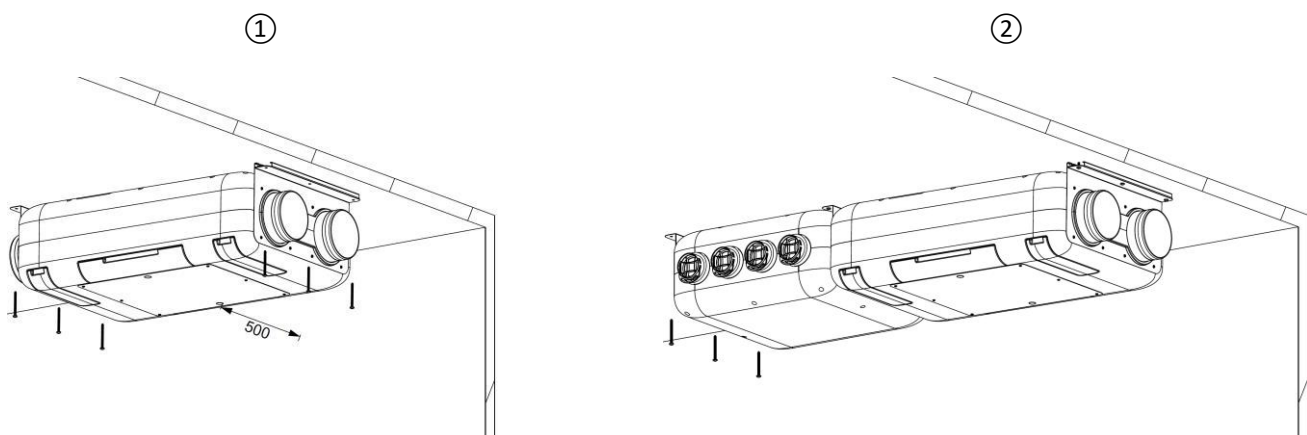

- If the unit is built with an underside housing, allow at least 150 mm free space for the condensate drain trap.
- **In the case of ceiling mounting, the device should be fixed with a slope of 1% towards the exhaust.** To maintain the proper slope, use the spacer profile included in the set.

③ - Left version (standard)

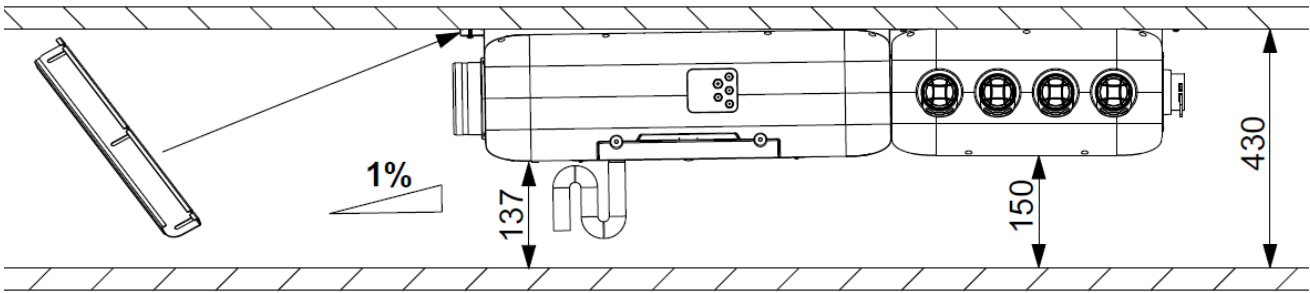

④ - Right version

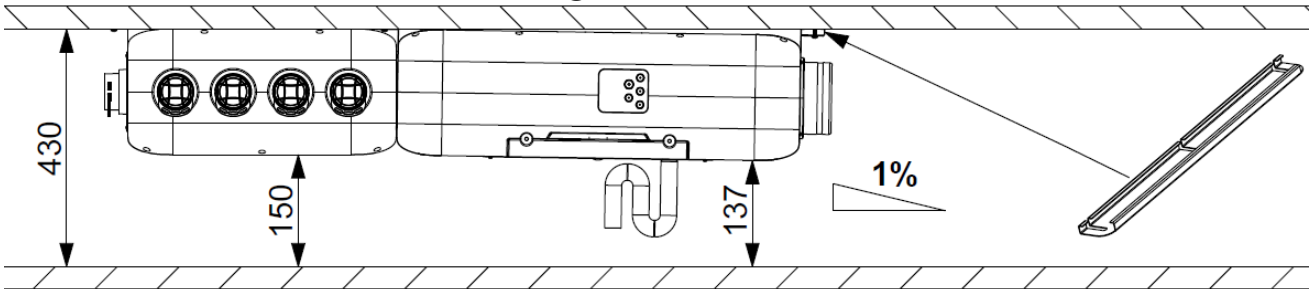

- The unit should be installed so as to enable its free opening for the replacement of filters, cleaning the exchanger and other maintenance.
- Make sure the power supply system is suitable for the maximum power of the appliance. The permissible temperature of the intake air is -20 to +50° C.
- The air handling unit should be installed in rooms where the temperature is min. 0°C.

Minimum lengths of ventilation ducts

To ensure the best efficiency of the air handling unit and to reduce aerodynamic losses due to turbulence, it is recommended to install a straight section of air duct at the entry and exit of the unit.

The minimum recommended lengths of such straight sections:

- 25 cm of an air conduit at the inlet side;
- 60 cm at the outlet side.

In case of lack or short air ducts on one or several ports of the air handling unit it is necessary to protect the unit's internal parts against entry of foreign objects, for example, install a protective grid or other device with mesh size not larger than 12.5 mm, to prevent free access to the fans.

If the source of noise is where the spiral air duct is connected, replace the spiral air duct with a flexible duct to avoid resonance. Flexible inserts can also be used to prevent resonating.

Draining of condensate

Connect the flexible condensate drain pipe to one of the ports of the drip tray, depending on the unit configuration (LEFT/RIGHT). The dia. 32 mm pipe should be bent to form a trap (the height difference between the upper and lower elbow of the trap should be at least 100 mm). The drain pipes have to be arranged with a slope of approximately 2%.

NOTE: Fill the drain system with water, before starting the unit for the first time! The drain trap must be filled with water during operation at all times.

Make sure that water flows into the drain, otherwise condensate may accumulate inside the unit when the recuperator operates, which in turn may damage the unit and cause water leakage into the room.

The condensate drain system must be used in all rooms, in which air temperature is above 0°C! If the room temperature is below 0°C the condensate drainage system has to be thermally protected and equipped with a heating device to prevent it from freezing.

ATTENTION! Condensate drainage is also recommended in air handling units with an enthalpy exchanger, as in special cases a small amount of condensate may accumulate.

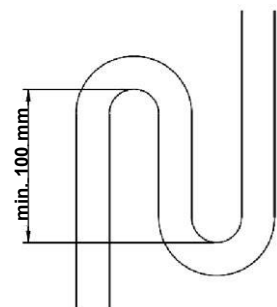

Connecting to the mains power supply

The unit must be connected to a 230 V/50 Hz single-phase AC power supply network, using the original power cord provided with the unit. Before connecting to the mains, check the cable for any mechanical damage caused by crushing, cutting etc., which may result in an electric shock.

The unit must be connected to the power network, in compliance with the regulations and standards in force.



ATTENTION!

The control panel should be connected to a properly installed socket equipped with an earthing contact. The power outlet should be located in an easily accessible place so that the plug can be pulled out easily in case of danger. The panel ratings are given on the manufacturer's factory label. Any changes to the internal connection are prohibited and will void the warranty.

Installation of air ducts

- The ventilation ducts should be secured against slipping from the connection stubs with cable ties.
- The distance between the air intake and the outlet should be at least 1.5 m.
- The air intake should be located on the shadiest building side as far as possible from sources of stale air (street, chimney, etc.)
- Install the exhaust air duct with a slope to the unit.
- All ducts should be insulated to avoid inside condensation and excessive moisture accumulation.
- When installing the ducts, minimise the number of sharp bends, etc., to reduce resistance of the ducts.
- The ducting should be airtight. Use fittings with gaskets or seal the joints with e.g. adhesive aluminium tape.
- To reduce the transmission of vibrations and to make the unit run more quietly, connect it to the system with flexible dampers on the intake and exhaust sides.
- The installation should follow a design prepared by an authorised designer.
- Make flow adjustments on the diffusers, based on measurements taken with an anemometer according to the air balance obtained.
- Ceiling diffusers should be installed min. 30 cm from the walls.
- To ensure adequate flow between rooms:
 - The gap under the internal door should have a minimum surface area of 7600 mm²
 - At least 10 mm gap under a standard internal door with a width of 760 mm
 - **Do not cover the openings as this will disturb air circulation**
- Recommended duct thickness depending on ambient temperature:

Air duct type:	Ventilation duct ambient temperature		
	from -20°C to 0°C	from 1°C to 14°C	from +15°C to 20°C
	Insulation thickness for a given temperature range		
Supply	20 mm + (200 mm)*	50 mm	20 mm
Exhaust:	20 mm + (200 mm)*	50 mm	20 mm
Intake	50 mm	50 mm	50 mm
Discharge	20 mm + (200 mm)*	20 mm	20 mm

*20 mm mineral wool insulation covered with aluminium foil on one side + a minimum of 200 mm of mineral wool as a covering or casing for pipes laid in the attic without thermal insulation.

1.12. MAINTENANCE



ATTENTION!

It is absolutely necessary to disconnect the control panel from power supply before performing any maintenance operations.



ATTENTION!

Do not use corrosive chemicals and solvents during any maintenance work.

Filter replacement/cleaning

Fouled filters increase air flow resistance which reduces the amount of air supplied to the rooms, and increases power consumption by the fans.

The filters should be cleaned as they become dirty, but at least 3-4 times per year. It is permitted to clean the filters with a vacuum cleaner. After cleaning twice, the filters should be replaced with new ones.

Optionally the air handling unit can be equipped with a pre-filter to extend the life of the fine filters. The pre-filter should be rinsed under running water and then dried before re-insertion, as it is reusable.

Filter replacement procedure

- Remove the filter caps (1);
- Remove the pre-filters (2) – optional;
- Remove the M5/F7 filters (3);
- Install new or cleaned filters according to the above diagram in reverse order.
- Reset the dirty filter counter in the control panel menu.

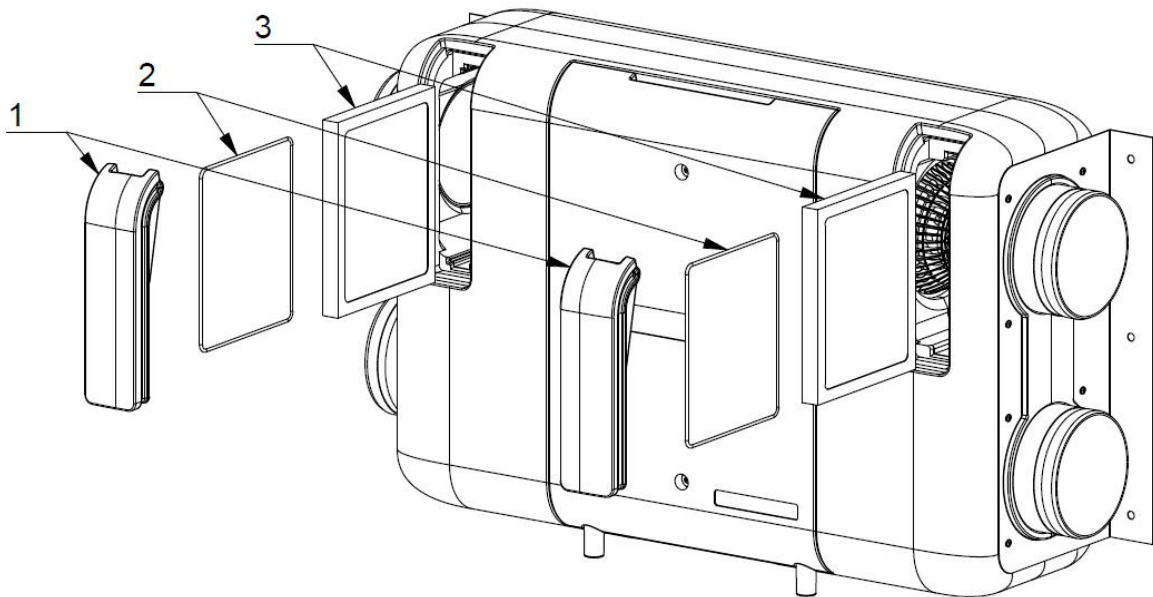

CAUTION: When replacing the filters, make sure the arrow points in a direction compatible with the air flow.



ATTENTION!

When replacing or cleaning the filters, also check that the pre-heater heat sink is clean. If necessary, clean the heat sink with a vacuum cleaner or compressed air.

Heat exchanger maintenance (annually)

Even with regular filter maintenance, dust deposits can form in the unit. In order to maintain high heat transfer efficiency, the heat exchanger should be cleaned regularly. Remove the heat exchanger from the main unit and wash it with warm water solution of neutral detergent, then reinstall the dried heat exchanger.

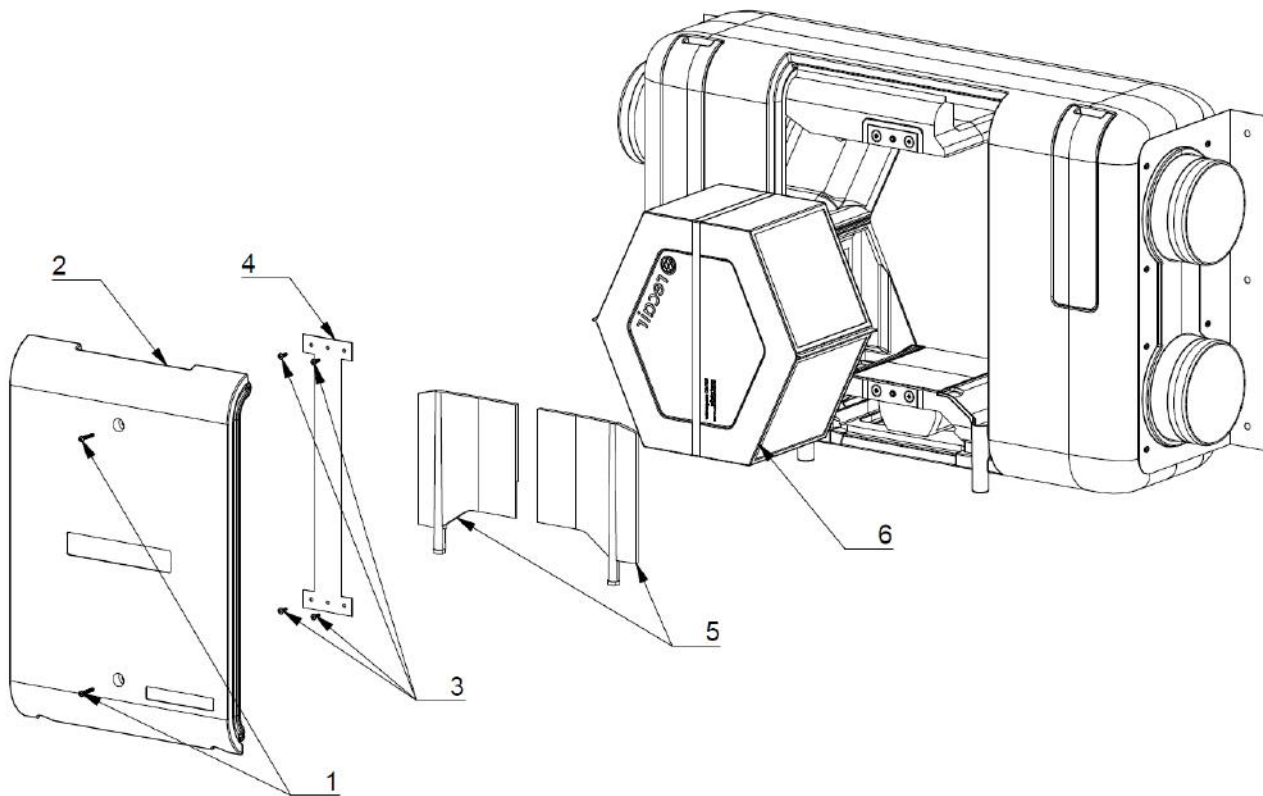

Heat exchanger/fan cleaning procedure

- Remove the locking screws (1);
- Remove the locking screws (1);
- Remove the heat exchanger snap-in shield (2);
- Remove the fixing screws (3);
- Remove the exchanger bracket (4);

CAUTION: For the ceiling mounting, the exchanger can slide out after unscrewing the bracket!

- Remove the drip trays (5)
- Remove the heat exchanger (6) completely and rinse with running water (reassemble after drying);
- After cleaning, assemble the unit according to the above diagram in a reverse order.

Maintenance of the condensate drain system (once a year)

The condensate drain system (drain pipe) may be contaminated by particles from the evacuated air. Check the function of the drain pipe, by filling the drain tank with water and, if necessary, removing dirt from the drain trap and drain pipe.

Maintenance of air intake and exhaust ducts (twice a year)

Leaves and other impurities can clog ventilation grates and reduce both the efficiency of the unit and air flow. Check the intake/exhaust grille twice a year and clean it, if necessary.

Maintenance of the air ducting (every 5 years)

Even if all the aforementioned maintenance activities of the air handling unit are performed properly, dust deposits may build up inside the air ducts, which reduces the air handling unit's efficiency. Air ducts are maintained by periodic cleaning or changing them.

11.13. PRE-HEATER / SECONDARY HEATER

The unit comes with a preheater which is one of the means of preventing the heat exchanger from freezing when outdoor temperatures are below zero. Other defrosting methods include, for example, a function to temporarily stop the supply fan.

Service settings configuration for operation with the preheater:

- defrosting temperature (default 5°C)
- defrosting method (set to HEATER)
- defrosting control range (default 1.5°C)



CAUTION!

A missing or damaged exhaust vent sensor turns off the heater.



CAUTION!

The preheater provides effective protection against exchanger freezing down to an external temperature of -15°C.

For lower temperatures, it is recommended to select the HEAT + FAN defrost option.

The air handling unit also has the option of controlling a secondary heater located outside the unit. Connect the secondary heater according to the diagram in Chapter 5.

1.14. WASTE MANAGEMENT NOTICE

Do not dispose of waste electrical equipment with household waste.



The crossed-out wheeled bin symbol on this product indicates that it is waste electrical and electronic equipment (WEEE) at the end of its operating life and shall not be disposed with household waste. The crossed-out wheeled bin symbol specifies that the product is subject to obligatory waste segregation schedules for proper disposal. The product is made from recyclable materials and components. The product user shall be required to return the product which has become WEEE to a WEEE collection unit. The operators of WEEE collection units, including local WEEE locations, product resellers and other WEEE collection locations managed by local authorities form a proper waste disposal system. Proper WEEE disposal helps avoid harmful effects to humans and the environment from the risk caused by hazardous components this product may contain. Your household can make an important contribution to the recovery and recycling of WEEE. This

contribution fosters a behaviour which helps conserve the natural environment, which is a common asset for the mankind. Households are among the leading consumers of small appliances and equipment. A rational management of operation and disposal of small appliances and equipment will contribute to efficient recycling.

2. NANO COLOR CONTROL PANEL

2.1. OPERATION PRINCIPLE

The NANO COLOR determines the set room temperature and ventilation performance based on the selected operating program.

Possible programs:

- **By clock zones.** You can set up two Comfort operation zones and one Out of Home zone (no is one in the apartment). Outside of these zones the Economy zone applies.
- **Holiday mode.** As above, but according to a separate daily program.
- **Manual mode.** One manually set temperature and one ventilation rate apply all the time.
- **Out of Home.** The settings as for the Out of Home zone apply all the time. This mode can only be set with the thermostat number 1. The other thermostats adopt this mode from the thermostat number 1. Cooling in the Out of Home program is turned off.

The set and ventilation temperature can still be affected:

- Enabling the URLOP mode. The thermostat and ventilation work as in the Out of Home mode.
- The Out of Home EXT signal, e.g. the one coming from a control panel. The thermostat and ventilation work as in the Out of Home mode.

The difference between the HOLIDAY and the Out of Home in NANO 1 and Out of Home in the EXT software lies in different interpretation of these states by the remaining equipment, e.g. the HOLIDAY mode switches off the DHW generation in boiler controllers and heat pumps, while solar collectors stop accumulating heat and switch to the collector overheating protection mode.

All of the above modes can only be set to NANO number 1. NANO1 then transfers them to the other NANOs and other devices.

NANO COLOR can work in one of the three system operation modes:

- **WINTER** - NANO COLOR functions as the heating thermostat. The related equipment tends to achieve the set temperature in the room, e.g. switching on the heating. The ventilation heats up the supplied air to the appropriate temperature. The particular reaction depends on the configuration of the related equipment
 - **SUMMER** – heating and cooling functions are off
 - **COOLING** – heating is off. NANO COLOR functions as the cooling thermostat. The related equipment tends to cool the room to the set temperature, e.g. by switching on fan coils, supply air cooler, opening the recuperator BY-PASS if the conditions so require. The HOLIDAY, Out of Home and Out of Home EXT modes block the cooling operation.
- The system operation mode can be changed manually or can change automatically depending on the outside temperature.

2.2. INSTALLATION

General

The work related to connecting and assembling should only be carried out by persons with the appropriate qualifications and permissions, and in line with the valid standards and regulations.

NOTE: Any connection work must only be carried out when the supply voltage is isolated, make sure that the electrical conductors are isolated.

Power supply

The NANO COLOR control panel should be powered directly from AERO 4 controller outputs marked with “U” and “G” symbols (12 VDC)

Connecting

The NANO COLOR control panel should be wired with a conductor of the minimum cross-section of 0.5 mm² according to the diagram in section CONNECTION DIAGRAMS. The minimum distance between conductors connecting the panel with the module and other devices connected to the C14 network and parallel conductors supplied with 230 VAC is 30 cm. A shorter distance may cause communication interference or damage to the device.

The following figure shows an example of a C14 network connection.

NOTE: In order to ensure smooth data transmission it is necessary to install a ferrite filter on the power and communication wires between the AERO module and the NANO COLOR thermostat. When leading the conductors through the filter loop them around the ring as shown in the photo at the side.















Installation site

The NANO COLOR control panel is installed in the front panel of the air handling unit as a standard. It is possible to relocate or install an additional panel in the desired location in the house. The panel should be installed at the height of about 150 cm from the floor, away from sources of heat (e.g. radiators, TV set) and cold (e.g. external doors).

2.3. DESCRIPTION OF THE MAIN SCREEN



- 1  Digital communication indicating via C14 protocol, flashing orange dot indicates that communication is in progress.
- 2  Menu button.
- 3 Operating mode button. Depending on the configuration, one of the following symbols will appear:
 -  Operation without a thermostat and ventilation.
 -  Operation with a thermostat.
 -  Operation with ventilation.
 -  Operation with a thermostat and ventilation.
- 4 Installation mode button. Depending on the selected mode one of the icons shown below is displayed:
 -  Winter (heating).
 -  Summer (without heating and cooling)
 -  Cooling.
- 5  EX4 module (displayed when the option is enabled).
- 6  Screen button for detected devices (support for additional devices).
- 7 Fireplace mode. Activation of the FIREPLACE function in the ventilation service menu is required.
 -  Fireplace operation mode enabled.
 -  Fireplace operation mode disabled.

8 The symbols appear for the enabled thermostat operation with heating and/or cooling. In the INTAKE TEMPERATURE CONTROL MODE, the ROOM option should be set in the ventilation service menu.



Signal to other devices that the room is not heated enough and the heating needs to be turned on.



Signal to other devices that the room is at the correct temperature (grey).



Signal to other devices that the room is overheated and cooling needs to be turned on.



Signal to other devices that the room is at the correct temperature (grey).

9 Ventilation on/off button.
It has to be turned on in the service parameter NANO / ON-OFF VENTILATION ON THE FIRST SCREEN.



Ventilation is switched on (green).



Ventilation is off (red). In addition to that, "OFF" will be displayed in field 14.

10 Current room temperature setpoint. Activation of the thermostat operation in service parameter VENTILATION/THERMOSTAT FUNCTION (Heating, Cooling, Heating+Cooling) is required.

11 The current reading of the information configured in the service parameter NANO/GENERAL INFORMATION.

12 Measurement of humidity in the room where NANO COLOR is installed.

13 Air quality and humidity. When pressed, a screen appears where detailed air parameters can be viewed. They are visible when sensors are connected. See section 2.11. for a detailed description.

14 Press to display a chart of the outside temperature variations over the last 24 hours, including the minimum and maximum temperatures recorded during that time. This information is not displayed if there is no outside temperature sensor.

15 Current ventilation operation status.

16 Current ventilation run. Displaying "OFF" means that the ventilation is switched off with the button 9.

17 Current ventilation operation mode (scheduled, holiday, manual).

18 Current work zone (comfort, eco, out of home, holiday).

19 Current operating status of the thermostat.

20 Current operating status of the thermostat (schedule, holiday, manual).









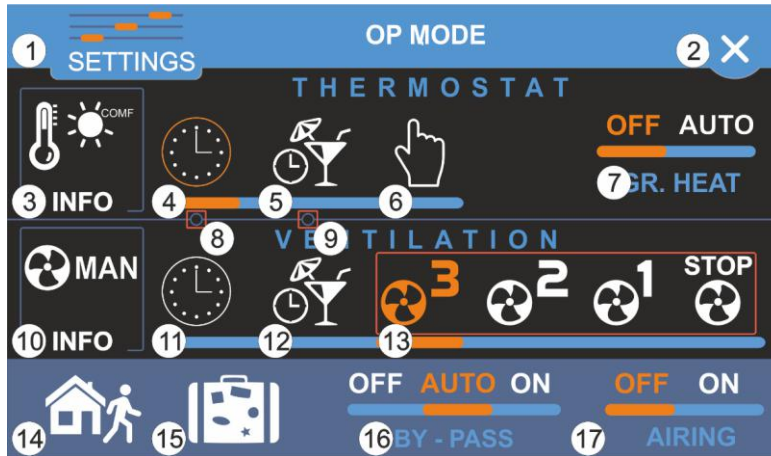



21 Current work zone (comfort, eco, out of home, holiday).





21  12:01Mo Clock. Press to display the date and time setting screen

2.4. OPERATION MODE

When the mode selection button (button 3 of the main screen) is pressed the mode screen appears, depending on the configuration.







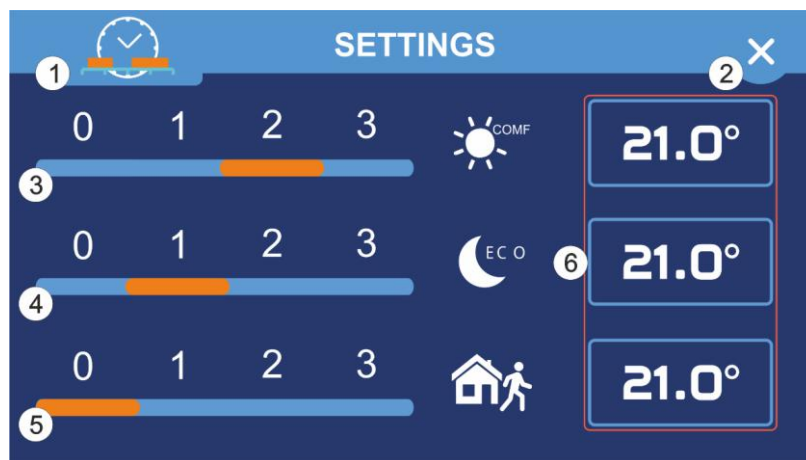

- | | | |
|----|---|---|
| 1 |  | Moves to the thermostat and ventilation settings. See the SETTINGS section for a detailed description. |
| 2 |  | Returns to the main screen. |
| 3 |  | Moves to the thermostat information screen. |
| 4 |  | Scheduled mode. |
| 5 |  | Holiday mode. |
| 6 |  | Manual mode. |
| 7 |  | Activation of the GHE in automatic operation mode or deactivation. The GHE operation is possible after enabling the option. |
| 8 |  | Click to set the scheduled mode for the thermostat and ventilation simultaneously. |
| 9 |  | Click to set the holiday mode for the thermostat and ventilation simultaneously. |
| 10 |  | Moves to ventilation information screen. |
| 11 |  | Scheduled mode. |
| 12 |  | Holiday mode. |

- 13  Manual selection of the ventilation operation mode.
- 14  Enables the OUT OF HOME (NANO1) program.
- 15  Enables the HOLIDAY program.
- 16  Switches the BY-PASS to automatic mode, constantly closing or opening it.
- 17  Switches the ventilation to air mode. The option is invisible when the OUT OF HOME (NANO1) or HOLIDAY mode is on.

2.5. SETTINGS

Clicking the button 1 from the OPERATION MODES section brings up the following screen:



- 1  Moves to the schedule settings.
- 2  Exits to the previous screen.
- 3  Sets the fan speed for the comfort zone.
- 4  Sets the fan speed for the economic zone.
- 5  Sets the fan speed for the OUT OF HOME mode.
- 6  Click to display the temperature setting screen. APPEARS AFTER THE OPTION HAS BEEN ENABLED.

2.6. TEMPERATURE SETTINGS

Clicking the button 6 from the SETTINGS section brings up the following screen. Use the **-** and **+** buttons to set the desired temperature.

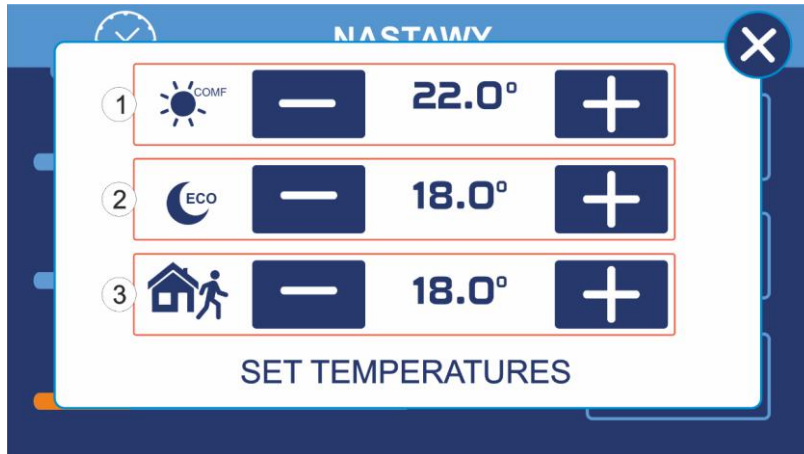

- 1 **-** 22.0° **+** Setting comfort temperature.
- 2 **-** 18.0° **+** Setting the economic temperature.
- 3 **-** 18.0° **+** Set the temperature in the OUT OF HOME mode.

2.7. THERMOSTAT INFO

After clicking the button 3 from the OPERATION MODE section, the screen will display the details of the currently measured room temperature and the temperature setting.

2.8. VENTILATION INFORMATION SCREEN

After clicking the button 10 from the OPERATION MODE section, the ventilation screen shows a window with a graphical representation of the exchanger.

NOTE: Depending on the connected devices installed in the air handling unit (heaters, coolers, AHU Kit), the screen may differ from those shown in the manual.

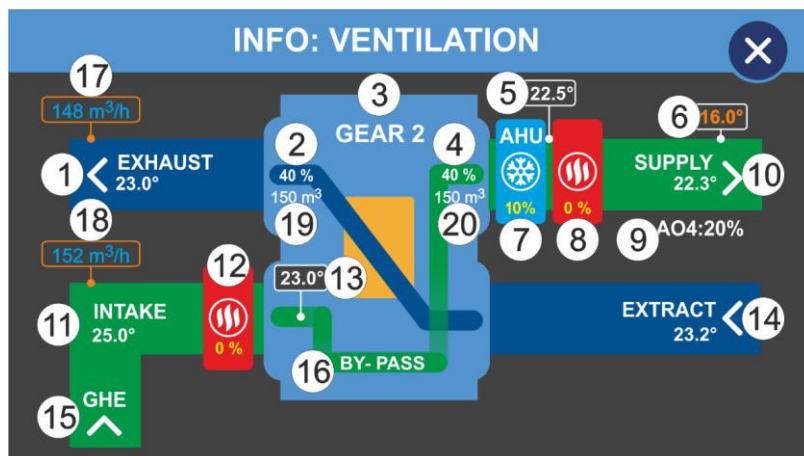

- 1 Exhaust temperature.
- 2 Exhaust fan rpm.
- 3 Ventilation run.
- 4 Supply fan rpm.
- 5 Temperature downstream the AHU Kit (only for the operating diagram 2).

- 6 Calculated intake temperature.
- 7 AHU Kit or cooler (only for the operating diagram 2).
- 8 Secondary heater (when the SECONDARY HEATER CONTROL function is enabled).
- 9 AO4 rpm.
- 10 Air supply temperature.
- 11 Intake temperature.
- 12 Preheater (when the defrost method is set using the preheater).
Temperature upstream the recuperator (when the MINIMUM TEMP. UPSTREAM THE RECUPERATOR function is enabled)
- 13 **Note:** An additional temperature sensor downstream the preheater is required.
- 14 Exhaust air temperature.
- 15 Ground-air heat exchanger – open.
- 16 BY-PASS – open.
- 17 Measured air exhaust flow.
- 18 Measured intake airflow.
- 19 The set value of the exhaust airflow.
- 20 The set value for the intake airflow.

2.9. FIREPLACE MODE

The fireplace, when enabled, increases the supply fan speed in relation to the exhaust fan by the value set in the parameter FIREPLACE RPM CORRECTION. Activating the mode disables the RECUPERATOR DRYING function.

NOTE: The installation has to meet the following requirements for the mode to operate correctly and safely:





- for the BY-PASS, it is forbidden to set the simplified operation mode;
- it is forbidden to set the speed of the exhaust fan higher than that of the supply fan – it applies to each speed;
- it is forbidden to set the exchanger defrosting by switching off the supply fan;
- it is forbidden to set the exchanger defrosting by switching on the pre-heater and reducing the supply fan speed by 50%.

2.10. CHANGING THE SYSTEM OPERATION MODE

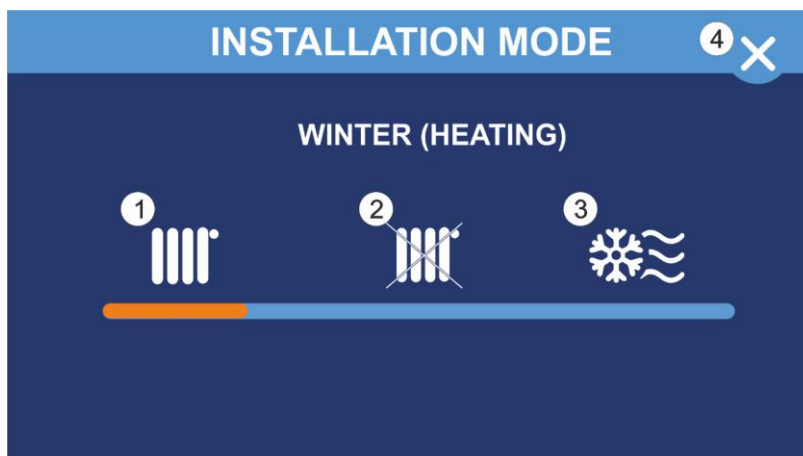
Changing the operation mode of the system can be done manually or automatically. The method is selected in the parameter WINTER/SUMMER MODE CHANGE METHOD.







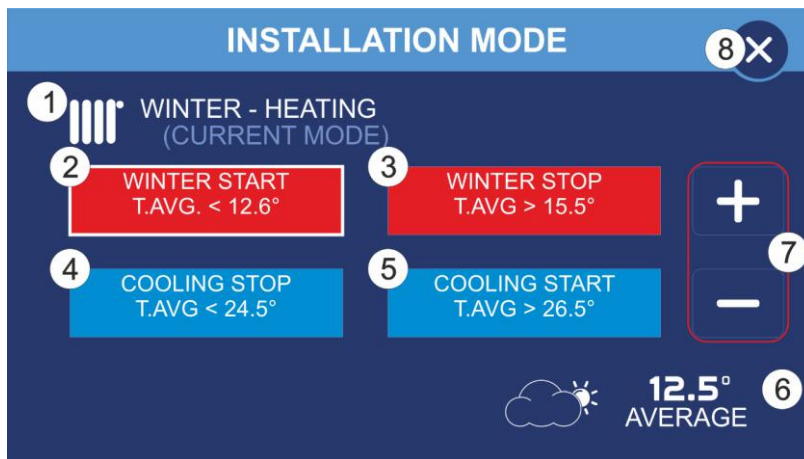

In the case of a manual change, the following screen will appear on the main screen when the button 4 is pressed:



- 1  Activation of the WINTER mode (HEATING).
- 2  Activation of the SUMMER mode (NO HEATING AND COOLING).
- 3  Activation of the COOLING mode.
- 4  Exit to the main screen.

In case the parameter WINTER/SUMMER MODE CHANGE METHOD is set according to outdoor temperature or according to average temperature 1 or 2, the operation mode screen of the system will be as shown below



- 1  WINTER - HEATING (CURRENT MODE) Current system operation mode.
- 2  WINTER START T.AVG. < 12.6° Setting the temperature below which the WINTER mode is switched on. Highlighted item means that the parameter can be edited.
- 3  WINTER STOP T.AVG > 15.5° Sets the temperature above which WINTER mode is switched off.
- 4  COOLING STOP T.AVG < 24.5° Sets the temperature below which the COOLING mode will turn off.
- 5  COOLING START T.AVG > 26.5° Sets the temperature above which COOLING mode is activated.
- 6  12.5° AVERAGE Depending on the selection of the winter/summer mode change method, it displays the current outside temperature or the average temperature.
- 7  +
- Decrease/increase the selected temperature by 0.1°C. The buttons are displayed when the parameter to be edited is selected.
- 8  Exit to the main screen.

NOTE: The difference between the temperatures WINTER START and WINTER STOP, WINTER STOP and COOLING STOP, COOLING STOP and COOL START must be at least 1°C. When increasing the temperature, this difference automatically transfers to the other settings.

2.11. SENSORS

Depending on the version, the device can additionally have built-in room humidity and/or CO2 level sensors. The device supports up to 5 sensors of different types to be connected.

NOTE: If more than 2 sensors are connected, select **MASTER** in the **NANO** menu under the **C14 NETWORK MODE** option. Connected sensors are displayed on the main screen (icon 13). Clicking the caption displays the readings from all connected sensors. The maximum measured value is highlighted. Below, a sample sensor information screen is shown:

SENSORS			
1	NANO1	HUM:35.3% T:24.2°	
2	NANO2	HUM:28.6% T:23.3°	
3			
4			
5			
6	SHC6	HUM:32.4% T:25.2°	CO2: 829PPM
7	SHC7	HUM:30.8% T:24.7°	CO2: 951PPM
8			
9			
10	SPM	HUM:40.1% T:21.9°	CO2: 782PPM
		PM1: 13	PM2.5: 17 PM4: 17 PM10: 19

VACS-1 air quality sensor

If the maximum value of CO2 concentration in the air is exceeded, the fans' speed is increased by 1 stage. When the concentration returns to the optimum value, the fans run at the set speed.

VACS-1 is equipped with an automatic calibration algorithm. As to have proper reading, the room in which the sensor is located should be ventilated at least once a month, in order to correct the reference point. After connecting to the power supply the sensor shows the value of 500ppm CO2. The proper reading will appear only after 30 minutes.

NOTE: Only one VACS-1 sensor can be connected to the air handling unit.



Signalling diode outside the housing:

- 1 green blink / pause - the sensor is working properly.
- 2 green blinks / pause - no communication.
- Red and green alternating blinks – one of the sensors broke down.

VSPM air quality sensor

The SPM air quality sensor measures relative humidity, temperature, CO2 concentration and the amount of PM1, PM2.5, PM4 and PM10 dust in the air. After exceeding one of the parameters, the fan speed is increased by 1 step.

VSPM is equipped with an automatic calibration algorithm. In order for the indications to be correct, the room where the sensor is located should be ventilated at least once a month in order to correct the reference point. After connecting the power supply, the sensor gives a value of 500ppm CO2. The correct indication will only appear after 30 minutes. Full calibration can take place even after several days of continuous use of the device.

NOTE: Only one VACS-1 sensor can be connected to the air handling unit.

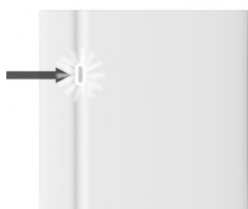

Signalling diode outside the housing:

- Slow increase and decrease of light intensity - normal operation
- Single pulse – one of the measured values exceeded the set threshold
- Multiple pulse - many of the measured values have been exceeded (the number of pulses corresponds to the number of measurement types exceeding the set thresholds)
- Enable / Disable - damage to one sensor

CO₂ concentration and VSHC humidity sensor

If the maximum air humidity value is exceeded, the fans' speed is increased by 1 stage. When the maximum CO₂ concentration in the air is exceeded, the fans' speed is increased by 1 stage. If the maximum values of humidity and CO₂ concentration are exceeded simultaneously, the fans' speed is increased by 2 stages. After the humidity level and CO₂ concentration return to their optimum values, the fans operate at a set speed.

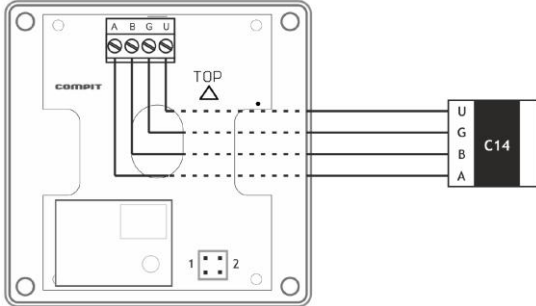

1	2	Sensor number
		Sensor No. 6
		Sensor No. 7
		Sensor No. 8
		Sensor No. 9

The setting of jumper links No. 1 and No. 2 defines the VSHC sensor address in C14 network. The sensors can have numbers from 6 to 9.

NOTE: A maximum of 4 VSHC or VSHW sensors can be connected.

VSHC is equipped with an automatic calibration algorithm. As to have proper reading, the room in which the sensor is located should be ventilated at least once a month, in order to correct the reference point. After connecting to the power supply the sensor shows the value of 500ppm CO₂. The proper reading will appear only after 30 minutes.

VSHW humidity sensor

If the maximum air humidity value is exceeded, the fans' speed is increased by 1 stage. The setting of jumper links B and C defines the VSHW sensor address in C14 network. The sensors can have numbers from 6 to 9.

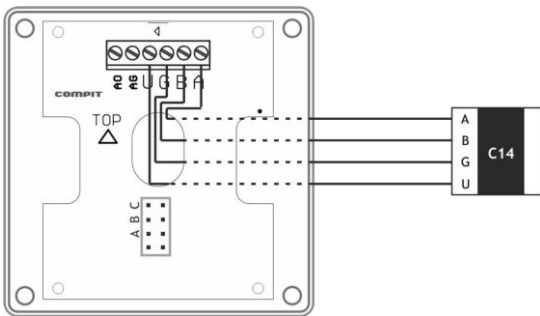

A	B	C	Sensor number
			Sensor No. 6
			Sensor No. 7
			Sensor No. 8
			Sensor No. 9

NOTE: A maximum of 4 VSHW or VSHC sensors can be connected.

Signalling diodes inside the housing:

STAT (green):

- 2 blinks and a long pause – no connection
- Continuous blinking – correct communication



RS (red)

- Each blink means a single data transmission to C14 network

2.12. VEX4 MODULE

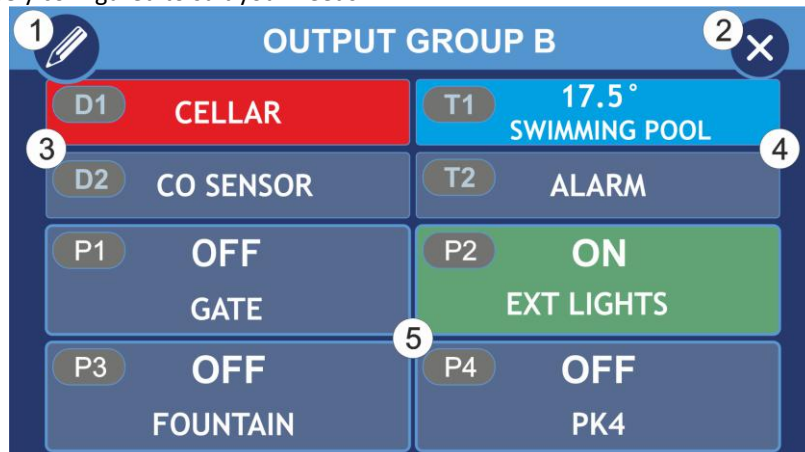
The VEX4 add-on module extends the functionality of the NANO COLOR room panel with additional inputs and outputs. The module can be freely configured to suit your needs.



- 1  Edit subtitles (visible when the Allow to edit subtitles option is enabled)
- 2  Exit to the main screen.
- 3 Digital inputs.
- 4 Digital inputs for temperature measurement (PT1000 sensor required).
- 5 Relay outputs.

Digital inputs

Digital inputs (D1-2, T1-2) allow you to monitor the status of any device equipped with a NO contact. When a signal is received, the field with the corresponding input number will illuminate red. If the input has been configured to display an alarm, the information will also appear on the home screen. Inputs T1 and T2 enable temperature measurement after proper configuration.





Relay outputs

The relay outputs enable control of external devices, home automation systems, e.g. lighting, roller-blinds, garage doors.

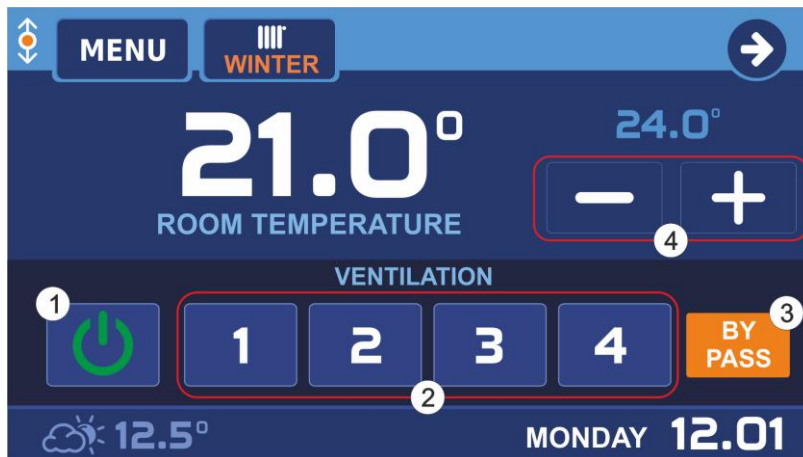
2.13. SMART MODE

It enables direct control of ventilation efficiency, and simplifies setting of temperature set-points. By default it is deactivated, but it can be activated by selecting the **NANO/PANEL OPERATION IN SIMPLE MODE** option in the service menu.



- | | | |
|---|---|---|
| 1 |  | Activation/deactivation of ventilation |
| 2 |  | Adjusting ventilation speed |
| 3 |  | Open/close the BY-PASS |
| 4 |  | Decrease/increase the current desired temperature |

2.14. FOULED FILTER INDICATION

Filter fouling can be signalled in 2 ways:

1. Text flashing on the main screen:
CHANGE AIR FILTER





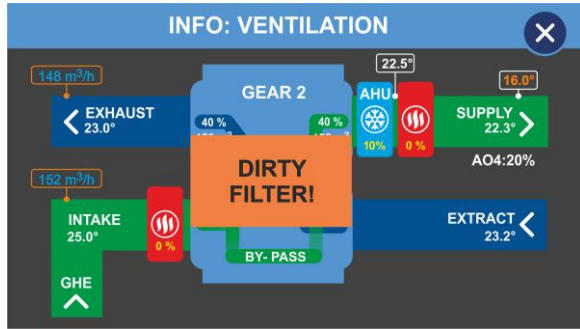



2. DIRTY FILTER! text flashing on the VENTILATION INFO screen.

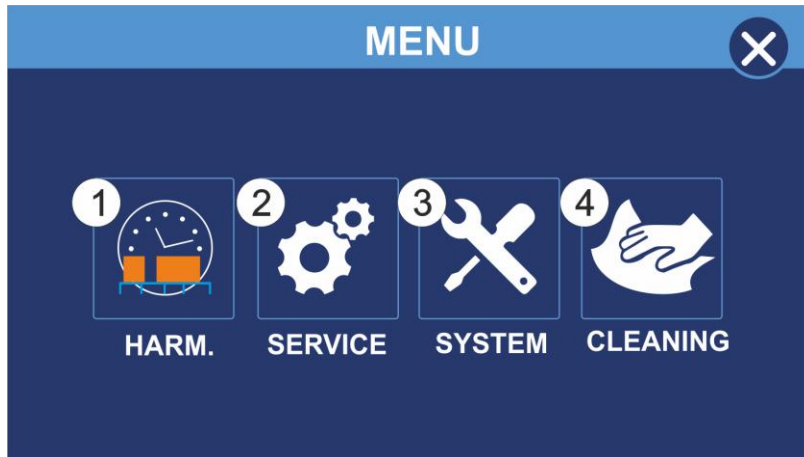

2.15. MAIN MENU

The main menu is accessed by pressing the MENU button on the main screen.



- 1  Setting the thermostat operating schedule (Section 2.16)
- 2  Maintenance settings. (Section 2.17)
- 3  System settings. After selecting this option, you can change the panel language, enable or disable sounds when alarms occur, set the brightness of the display and customise the device screens.
- 4  Screen cleaning function. When this option is selected, the screen locks for 30 seconds
- 5  Exit to the main screen

2.16. SCHEDULE SETTINGS

To access the schedule settings, press HARM in the menu.

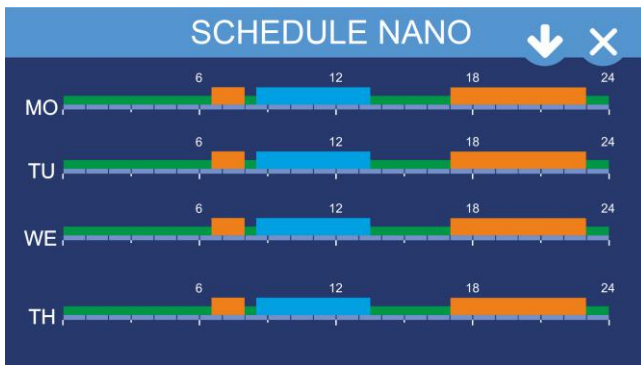

View of the weekly schedule.

Press to move on to the remaining days of the week and holiday schedule settings.

By clicking the bar of the selected day schedule you enter the edit window.

Pressing will take you to the main menu.



Edit schedule window for Monday

You can set 2 comfort zones and an out of home zone. Outside these zones, the economic zone applies.

On the top, there is a graphical representation of the currently set zones.

To edit a zone, click the item you want to change.



Use and to set the start time

of the first zone () and its end (). The currently edited item will be highlighted. Similarly, you can set the subsequent zones.

If you want to have identical settings for the other days of the week, click .



A window with the days of the week will open. Select the items to which you want to copy the settings and click .





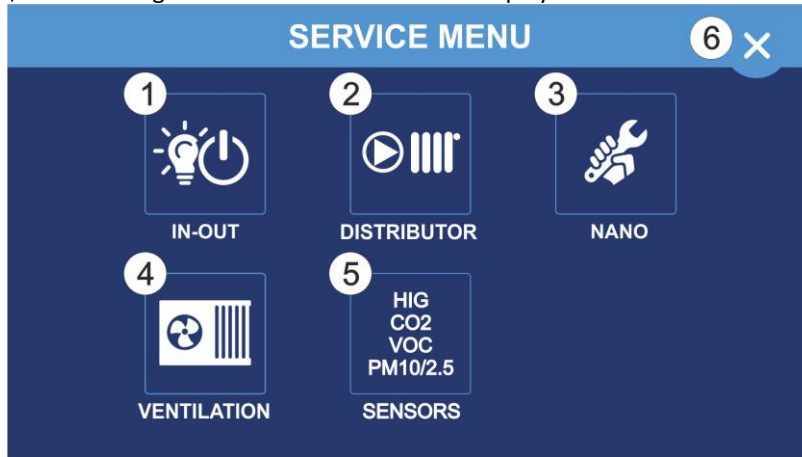

2.17. SERVICE MENU

When you click on the SERVICE button in the main menu, the screen for setting the access code appears.

NOTE: When code 99 is entered, the service menu screen with user parameters will be displayed, while when the 199 code is entered, parameters for the service technician/installer will also be available.

After entering the code, the following service menu will be displayed.



- | | | | |
|--|---|--|--|
| <p>1 </p> <p>2 </p> <p>3 </p> | <p>IN-OUT settings. Configuration EX4 module of additional inputs and outputs.</p> <p>Distributor settings.</p> <p>NANO panel settings.</p> | <p>4 </p> <p>5 </p> <p>6 </p> | <p>Ventilation settings.</p> <p>Sensor settings.</p> <p>Exit to the main screen.</p> |
|--|---|--|--|

Below, a diagram of the service menu structure is shown:

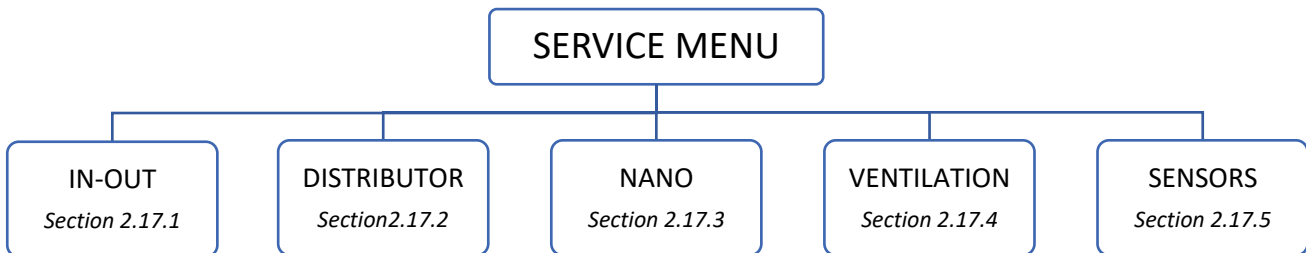

2.17.1. IN-OUT

EX4 module support

Enables operation with an additional VEX4 module.

EX4 – D1 input config

Configures D1/D2 input settings

- None – input not supported, will not be displayed on the outputs screen.
- Info only – the input status will only be displayed on the outputs screen.
- Info+alarm – the input status will be displayed on the output screen and the main screen.

EX4 - T1/T2 input config

Configures T1/T2 input settings

- None – input not supported, will not be displayed on the outputs screen.
- Info only – the input status will only be displayed on the outputs screen.
- Info+alarm – the input status will be displayed on the output screen and the main screen.
- Temperature – an input configured to measure temperature.

2.17.2 DISTRIBUTOR

Distributor – cooling support

Enables using a floor distributor with a cooling system. The parameter is related to working with the L1 and L2 blocks used to control the floor and wall circuits.

Distributor – PWM support

The PWM control is based on cyclical switching on of the circuit for a specified period of time. The activation time depends on the difference between the temperature set-point and the room temperature. If the function is deactivated, the NANO controls the operation of distributor circuits just like a regular thermostat with active hysteresis. The parameter is related to working with the L1 and L2 blocks used to control the floor and wall circuits.

2.17.3. NANO**NANO Number**

This parameter is used to set the NANO number. Each NANO in the C14 network must have its own unique number. Range 1...10

C14 network mode

- SLAVE – responds to inquiries from the MASTER.
- MASTER – manages communication between devices on the C14 network.
- MASTER MINI – manages communication between devices in the C14 network (recommended up to 2 devices in the C14 network). Information exchange between devices is faster.

There can be only one MASTER device in the C14 network.

Set temp. in comfort mode

Sets the comfort temperature.

Set temp. in eco mode (winter)

Sets the preset eco temperature when the WINTER mode is on.

Set temp. in eco mode (cooling)

Sets the preset eco temperature when the COOLING mode is enabled.

Set temp. in manual mode

Sets the preset temperature for manual operation.

Set temp. in away mode

Sets the preset temperature for the OUT OF HOME and HOLIDAY modes.

Thermostat adjustment

It is used to correct the temperature measurement in the room. Range: -10...+10°C.

Thermostat hysteresis

The thermostat hysteresis function prevents unnecessary activating of heating, if there are small temperature fluctuations. The greater the value of the hysteresis, the longer the cycles of the heating. Set-point range: 0.1...10.0°C.

Winter/summer change method

You can choose from any of the following options:

- Manual – the user changes the heating season setting individually.
- According to on the outside temperature:
 - when the thermostat is in WINTER mode, if the outside temperature rises above the set value it will automatically change to the SUMMER mode.
 - when the thermostat is in SUMMER mode, if the outside temperature drops below the set value it will automatically change to the WINTER mode.
- According to the average temperature 1 – measurement every 1 minute. When this option is selected, the measurements are averaged over the last 2.5 hours:
 - when the thermostat is in the WINTER mode, an increase in the average outside temperature above the set value causes an automatic change to the SUMMER mode.
 - when the thermostat is in SUMMER mode, a drop of the average daily outside temperature below the set value causes an automatic change to the WINTER mode.
- According to the average temperature 2 – measuring every 10 minutes. When this option is selected, the measurements are averaged over the last 24 hours:
 - when the thermostat is in the WINTER mode, an increase in the average outside temperature above the set value causes an automatic change to the SUMMER mode.
 - when the thermostat is in SUMMER mode, a drop of the average daily outside temperature below the set value causes an automatic change to the WINTER mode.

Ventilation easy mode operation

When switched on, the main screen displays a row of buttons to control ventilation.

Ventilation ON-OFF on the first screen

After switching on, a button enabling starting and stopping ventilation is displayed on the main screen.

Screen saver

This parameter enables activating a screen saver, which displays the time and temperature in the room.

Permission to edit texts

Permission to edit texts. Selecting this option enables editing the descriptions regarding outputs of the EX4 module and the names of heating circuits.

Main info

Displaying information on the main screen (item 10):

- Room – displays the currently measured room temperature.
- Air supply – displays the current ventilation airflow temperature.
- Air exhaust – displays the current ventilation exhaust temperature.

Thermostat function

You can choose from any of the following options:

- Off – Nano COLOR does not perform thermostat function.
- Heating – only the heating function is performed.
- Cooling – only the cooling function is performed.
- Heating + cooling – the heating and cooling functions are performed.

MODBUS address

Device address in the RS-485 MODBUS network (default setting: 44).

Return to factory defaults

Resets all settings and presets to factory default values.

2.17.4. VENTILATION

User parameters – access with code "99"

Service parameters – service code access

Away mode config

Sets the operation of fans in the OUT OF HOME AND HOLIDAY mode.

- Non stop – the fan runs all the time
- 30 minutes work/30 minutes stop (the unit starts up 30 minutes before the full hour)
- 20 minutes work/40 minutes stop (the unit starts up 20 minutes before the full hour)
- 20 minutes work/100 minutes stop (the unit starts up 20 minutes before the full odd hour)

Supply and exhaust fan settings

The parameters below define the capacity of the supply and exhaust fans at each speed.

- Supply fan speed in gear 1
- Supply fan speed in gear 2
- Supply fan speed in gear 3
- Supply fan during airing
- Exhaust fan speed in gear 1
- Exhaust fan speed in gear 2
- Exhaust fan speed in gear 3
- Exhaust fan during airing

Air supply min. temperature

When the air supply temperature is below the value set for this parameter, the controller will switch the supply off. Set-point range: 0...50°C.

Air supply max. temperature

Limitation of the maximum air supply temperature. Set-point range: 0...50°C.

Secondary heater control

If this option is enabled, the reheater will operate in the PWM mode.

Airing time

Sets the activation time for the ventilation function activated via DI2 input (only available for connection diagram 1).

- 0 – operation ON/OFF.
- 1 – 100 – turns the fan on for the preset time in minutes.

Show fireplace mode

Allows you to work with the fireplace mode.

Fireplace mode speed correction

Sets the increase in the supply fan rpm relative to the exhaust fan by the value set in this parameter.

Gear correction from sensors

Enabling this option increases the speed of the supply and exhaust fans on detecting the exceedance of the permissible levels by the sensors.

CSF system flow control

Activating the operating option of the balance flow for supply and extract air (Constant Flow).

NOTE: Function only available on models with the CF module.

Secondary heater control type

The supply air temperature is controlled by one of the following methods:

- room temperature function
- supply temperature function
- exhaust temperature function

Secondary heater correction (winter)

This parameter determines the value of the supply temperature correction gain in the winter mode.

Secondary heater correction (summer)

This parameter determines the value of the supply temperature correction gain in the summer/cooling mode.

Minimum temperature before heat exchanger

Defines the minimum air temperature upstream the recuperator. If the temperature drops below the setpoint, the preheater will be activated according to the selected operation mode. A setting of -10°C disables the function. (Connection of temperature sensor T5 is required for proper operation).

Temperature range before heat exchanger

Determines the temperature for which the output of the secondary heater is continuously controlled.

Secondary heater power correction

It defines the temperature for which the power of the post-heater is smoothly regulated.

Secondary heater Ki

Determines the rate of secondary heater power adjustment. The higher the value, the faster the adjustment. (If oscillations occur the values should be reduced).

Fans powerdown time

This parameter defines the delay for the fans to switch off. This delay ensures that the heaters are cooled down or that cold is received from the cooler, when the unit is switched off. Set-point range: 0-100 seconds.

Filter cleaning period

This parameter sets the time after which the controller indicates the need to clean the filters. A setting of 0 disables the option. Set-point range: 1-365 days.

Thawing temperature

If the temperature measured at the exhaust duct is lower than that set in this parameter the controller initiates the defrosting procedure with the selected defrosting method.

Thawing hysteresis

Determines the temperature for which the preheater power is continuously adjusted during defrosting of the exchanger.

Thawing method

Air handling unit defrosting can be done in one of the following ways:

- FAN OFF (supply air)
- HEATER – preheater is switched on
- HEATER + FAN (preheater is switched on + supply fan 50% efficiency)
- BY-PASS – the by-pass is opened

NOTE: The method of defrosting by opening the by-pass flap is only effective for the left-hand configuration version of the panel.

Temp. of air intake corres. to outside temp

When this function is activated, the temperature at the air intake is the same as the outside temperature, and this information is transmitted to other units in the C14 system.

Function of relay R3

Configuration of R3 relay function:

- GHE
- CH
- damper
- no function

Input DI2 function

- AIRING – Active ventilation mode turns on all fans at 100% power. Mode it can be configured to work ON/OFF or to be turned on for a set time.
- WTRACTOR – Active extractor mode reduces the exhaust fan speed by 1.

Ground heat exchanger winter

The value of outside temperature below which the Ground Heat Exchange is switched on in the winter. Range: -20...+40°C.

Ground heat exchanger summer

The outside temperature above which the GHE is switched on in the summer. Range: -20...+40°C.

Threshold for auto BY-PASS operation

The outside (air intake) temperature that allows the BY-PASS to open with the automatic BY-PASS operation. Set-point range: -22...+60°C.

BY-PASS control configuration

BY-PASS selection:

- Inactive.
- Simple – operation based on fan control
- Standard room temp. – enables operation in one of the following modes: closed, open, AUTO
- Standard exhaust temp. – enables operation in one of the following modes: closed, open, AUTO (temperature sensor T4 required)

Heat exchanger drying time

Setting a value above 0 activates the exhaust fan at 100% speed for the time set in this parameter. The function is activated 1 minute after switching on the OUT OF HOME mode, when the exhaust temperature was lower than 10°C since the last drying. Adjustment range 0-20 min.

Operating diagram

- Standard
- AHU KIT (Additional diagram. For more information, please contact the manufacturer)
- HP (Additional diagram. For more information, please contact the manufacturer)

2.17.5 SENSORS**Start airing CO2 exceeded (PPM)**

Specifies the level of CO2 concentration in the air, after which the fan speed is increased by 1 step. A VACS-1, VSPM or VSHC sensor is required for the function to work properly.

Stop airing CO2 exceeded (PPM)

It determines the level of CO2 concentration in the air after it has dropped and the fan speed returns to normal operation. A VACS-1, VSPM or VSHC sensor is required for the function to work properly.

Start wietrzeńia – Przekroczone VOC (PPM)

Specifies the level of concentration of volatile organic compounds in the air, when exceeded, the fan speed is increased by 1 step. For the function to work properly, it is necessary to have a sensor with VOC measurement.

Stop airing VOC exceeded (PPM)

Determines the level of volatile organic compounds after a drop in which the speed of the fans returns to normal operation. For the function to work properly, it is necessary to have a sensor with VOC measurement.

Start drying nano own sensor

Defines the level of humidity beyond which the fan speed is increased by 1 step.

Stop drying nano own sensor

Sets the humidity level beyond which the fan speed returns to normal operation.

Start humidification nano own sensor

Function disabled.

Stop humidification nano own sensor

Function disabled.

Start PM1.0 sensor SPM

Specifies the level of PM1.0 particle concentration, beyond which the fan speed increases. A VSPM sensor is required for the function to work properly.

Start PM2.5 sensor SPM

Specifies the level of PM2.5 particle concentration, beyond which the fan speed increases. A VSPM sensor is required for the function to work properly.

Start PM4.0 sensor SPM

Specifies the level of PM4.0 particle concentration, beyond which the fan speed increases. A VSPM sensor is required for the function to work properly.

Start PM10.0 sensor SPM

Specifies the level of PM10.0 particle concentration, beyond which the fan speed increases. A VSPM sensor is required for the function to work properly.

PM histeresis SPM sensor

It determines how much PPM the concentration of PM particles in the air must drop in relation to the starting values, so that the ventilation operation returns to the preset settings.

Thermostat start SPM sensor

Function disabled.

Thermostat stop SPM sensor

Function disabled.

Start drying SPM sesnor

Defines the level of humidity beyond which the fan speed is increased by 1 step.

Stop drying SPM sesnor

Sets the humidity level beyond which the fan speed returns to normal operation.

Start humidification SPM sensor

Function disabled.

Stop humidification SPM sensor

Function disabled.

LED signalization SPM sesnor

Shows how the LED lights up. There are options to choose from:

- LED standby - a lit LED means that the sensor is working
- Thermostat threshold - blinking diode means exceeded thermostat settings.
- Sensor threshold - blinking diode means exceeding the sensor settings (humidity, CO2, PM)

LED brightness SPM sensor

Specifies the level of LED lighting.

Thermostat start sensor no 6, 7, 8, 9

Function disabled.

Thermostat stop sensor no 6, 7, 8, 9

Function disabled.

Start drying sensor no 6, 7, 8, 9

Defines the level of humidity beyond which the fan speed is increased by 1 step.

Stop drying sensor no 6, 7, 8, 9

Sets the humidity level beyond which the fan speed returns to normal operation.

Start humidification sensor no 6, 7, 8, 9

Function disabled.

Stop humidification sensor no 6, 7, 8, 9

Function disabled.

LED signalization sensor no 6, 7, 8, 9

Shows how the LED lights up. There are options to choose from:

- LED standby - a lit LED means that the sensor is working
- Thermostat threshold - blinking diode means exceeded thermostat settings.
- Sensor threshold - blinking diode means exceeding the sensor settings (humidity, CO2, PM)

LED brightness sensor no 6, 7, 8, 9

Specifies the level of LED lighting.

3. NANO WIRELESS NETWORK

The NANO COLOR control panel can be connected also when cable connection is not possible. In that case, radium converters of the C14–VRS network should be used. Two converters must be used for proper operation. For the connection method, refer to the CONNECTION DIAGRAMS section.

4. MODBUS RTU PROTOCOL CONFIGURATION

MODBUS RTU communication settings::

- Default device address Modbus SLAVE: 44
- Transmission speed (BAUDRATE): 9600 bps
- Amount of data (DATA BITS): 8
- Stop bits (STOP BITS): 1
- Parity (PARITY): brak (NONE)

Detailed information on the installation via the MODBUS protocol can be found on the website www.awentapro.pl/dopobrania

5. VLAN iNEXT INTERNET MODULE

The iNEXT internet module allows remote control of the air handling unit. The control can be performed via a web browser. The method of connecting the iNEXT module is presented in the CONNECTION DIAGRAMS section.

NOTE: Connection via a web browser besides basic functions also gives access to service parameters of the device.

Configuration of the VLAN iNEXT Internet module

– control via a web browser

1. In order to properly use the iNEXT Internet system the user has to register and create an account at the website <https://inext.compit.pl>
2. To register a new user account click the “Register” button, the page will automatically load the registration form.
3. After completing the registration process click the “ADD GATEWAY” button which will be displayed on the welcome page or in the menu on the left side click “GATEWAYS” and then “ADD GATEWAY”.
4. Enter the code found on the rating sticker of the iNEXT VLAN Internet module in the “GATEWAY CODE” field.
5. After entering a correct gateway code, additional fields will be revealed. After clicking in the “CHOOSE MANUFACTURER” field, select “AWENTA PRO” from the list, and in the “INSERT NAME” field enter any name of your device.
* Additionally tick the “MASTER OPERATION” field.
6. After clicking the “ADD GATEWAY” command a window for device addition appears. Select “NANO COLOR” as the device type and enter 41 in the standard field.



Detailed information on how to install and use the iNEXT VLAN Internet module can be found at www.awentapro.pl/dopobrania

6. WIRING DIAGRAMS

6.1 ELECTRICAL DIAGRAM OF THE AERO 4 CONTROLLER – version for operation scheme 1. Standard

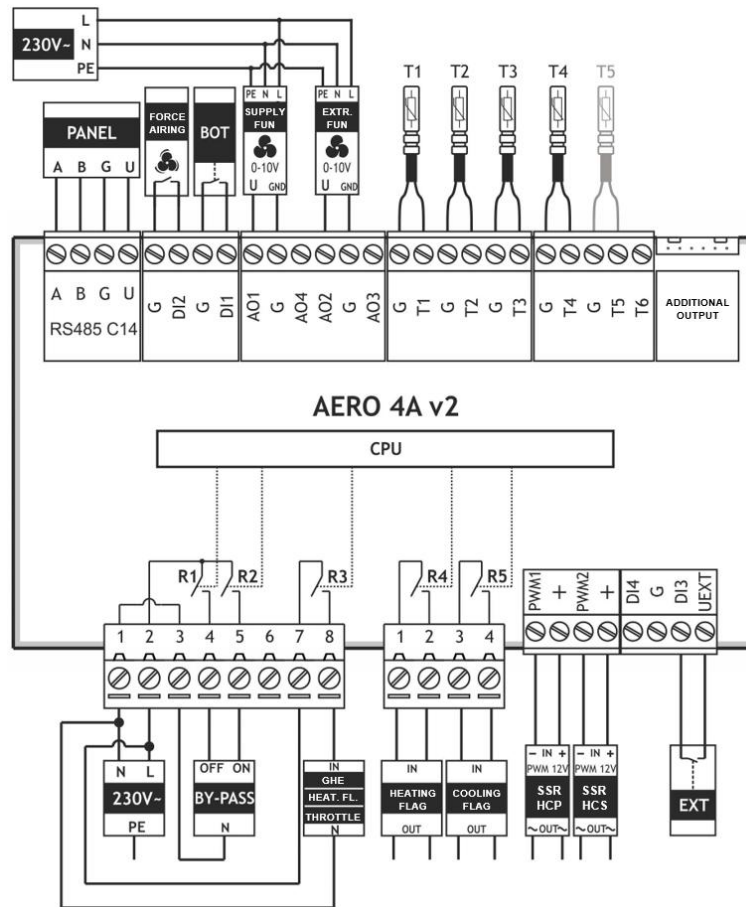

- R1 – BY-PASS closing
- R2 – BY-PASS opening
- R3 – GHE, heat from thermostat or damper flag (depending on configuration)
- R4 – heating signal from NANO thermostat (room is cooled down in WINTER mode)
- R5 – cooling signal from NANO thermostat (the room is overheated in COOLING mode)
- PWM1 – PWM digital output (-) for connecting the secondary heater SSR relay
- PWM2 – PWM digital output (-) for connecting the preheater SSR relay
- AO1 – supply air fan
- AO2 – extract air fan

Inputs:

- DI1 – temperature limiter (**When the unused DI1 input should be shorted with G**)
- DI2 – forced ventilation
- DI3 – digital input of the external device signal (e.g. control panel) to switch ventilation into the "Out of Home" mode (depending on configuration).
- UEXT – polarising output of EXT signal

Sensors:

- T1 – external temperature sensor
- T2 – supply temperature sensor
- T3 – discharge temperature sensor
- T4 – exhaust temperature sensor
- T5 – temperature sensor behind pre-heater (optional)

NOTE: Connect the control panel, the INEXT module and the air quality or humidity sensors to the corresponding terminals marked “U-G-B-A” using a 4 x 0.5 300/300 V cable. The total length of the cables should not exceed 30 m. Route the communication cables at least 30 cm away from the 230 VAC supply cables. Local crossing with 230 VAC cables is permissible.

6.2. CONNECTING THE NANO COLOR CONTROL PANEL

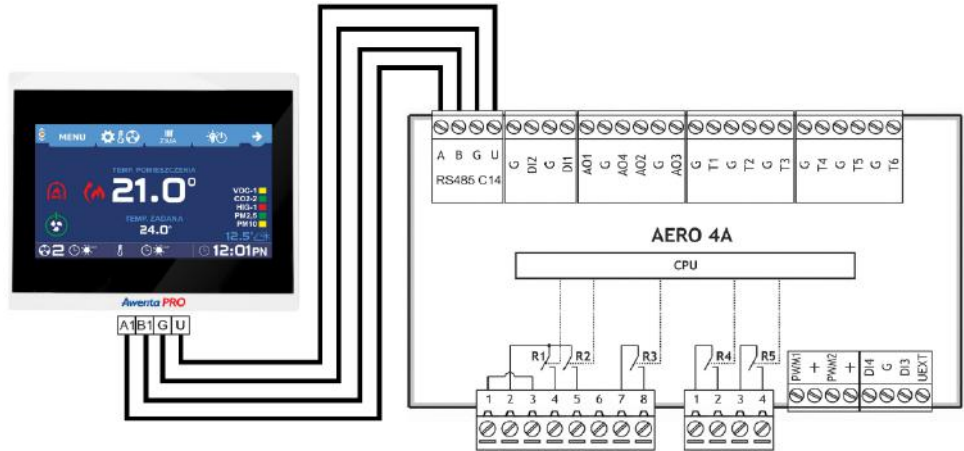

Note! The AERO 4 controller works only with NANO with number 1.

6.3. CONNECTING THE NANO COLOR CONTROL PANEL WITH C14 - VRS NETWORK CONVERTERS

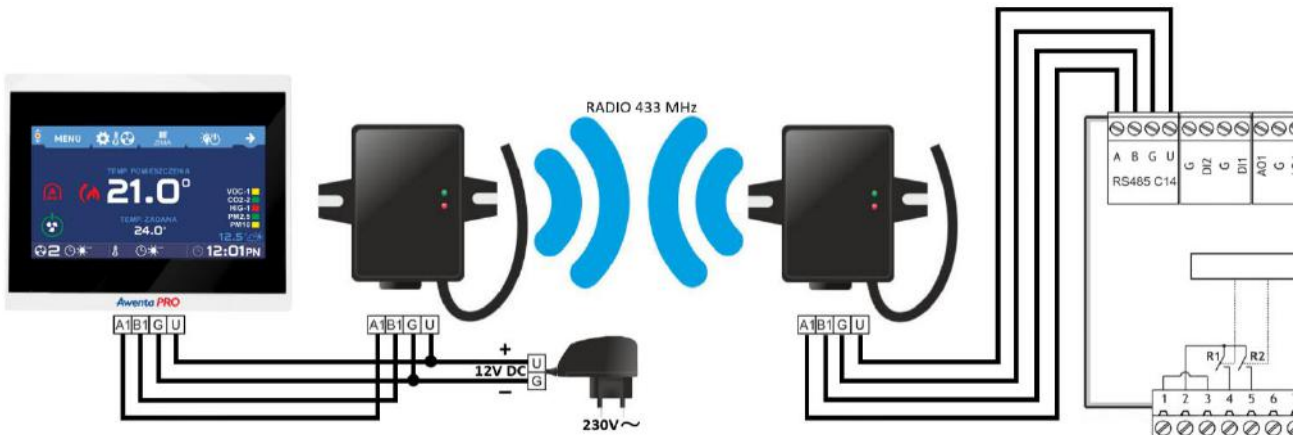

6.4. CONNECTING THE NANO COLOR CONTROL PANEL WITH THE iNEXT VLAN INTERNET MODULE

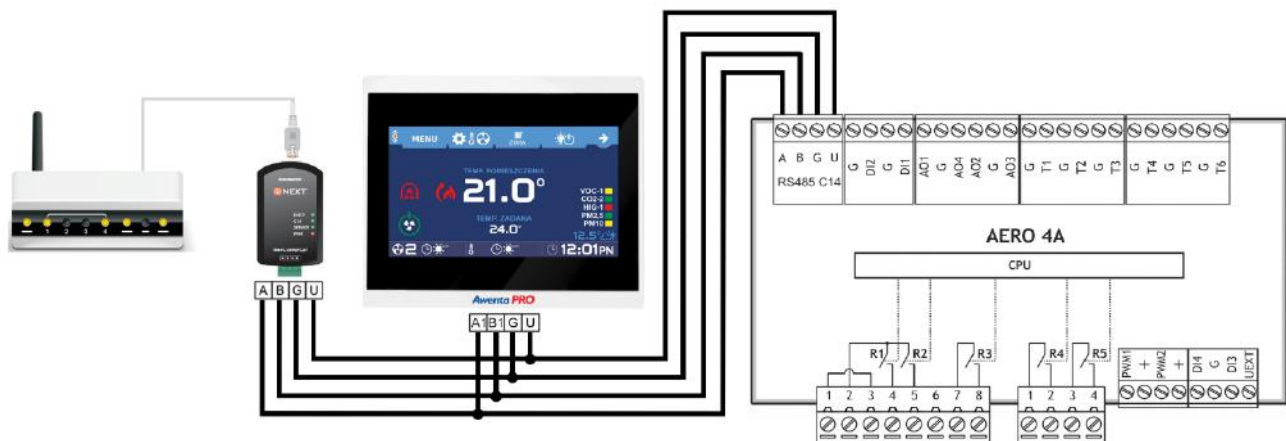

6.5. CONNECTING THE NANO COLOR CONTROL PANEL WITH VACS-1 or VSPM AIR QUALITY SENSOR

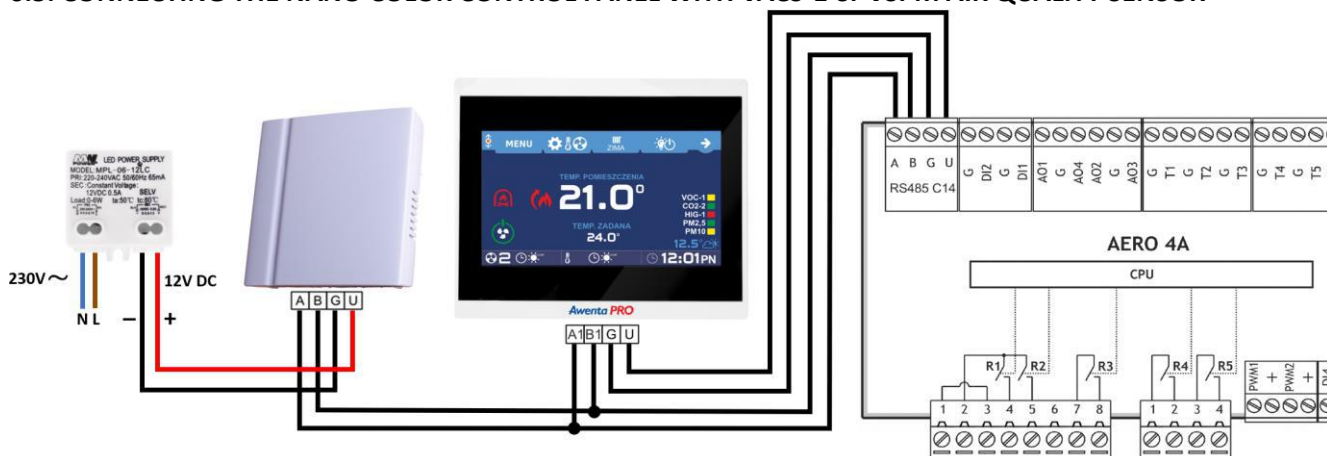

Note! Only one VACS-1 or VSPM sensor can be connected to the device.

6.6. CONNECTING THE NANO COLOR CONTROL PANEL WITH THE VSHC or VSHW SENSOR

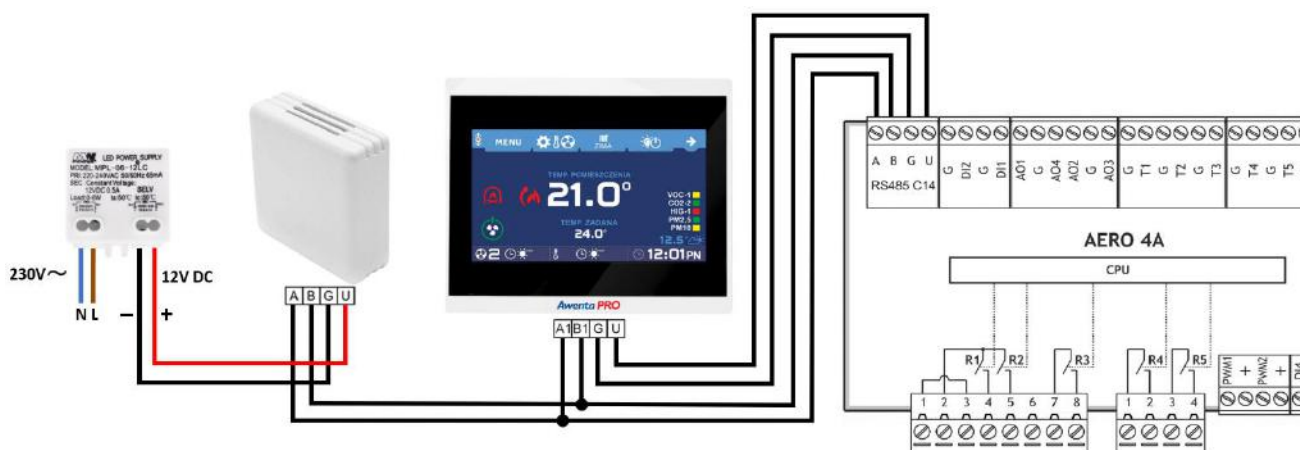

6.7. CONNECTING THE NANO COLOR CONTROL PANEL WITH VSHC or VSHW and VACS-1 or VSPM SENSORS

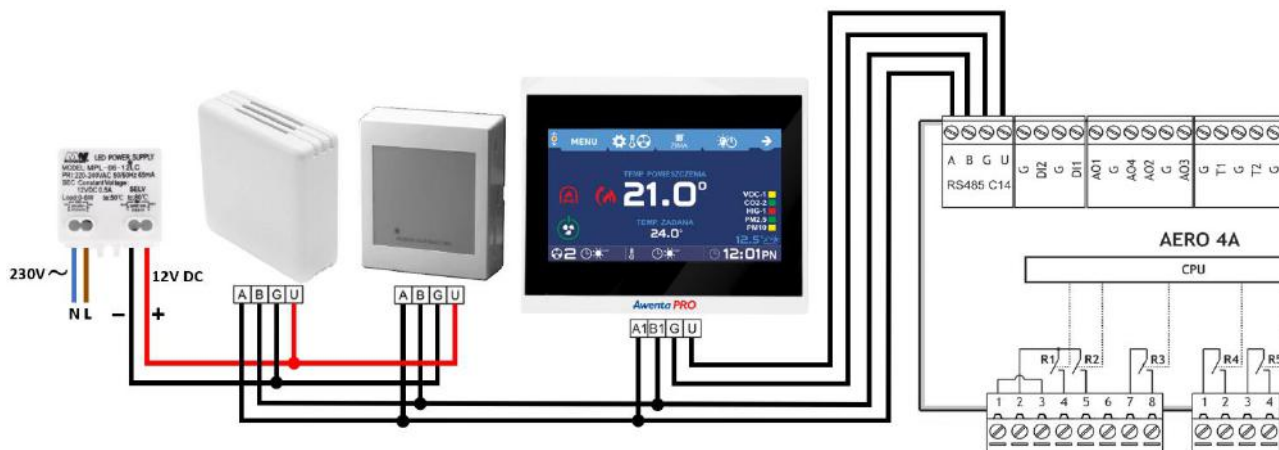

Note! Up to 4 VSHC or VSHW sensors and one VACS-1 or VSPM sensor can be connected to the device.

6.8. CONNECTION OF A PREHEATER AND SECONDARY HEATER

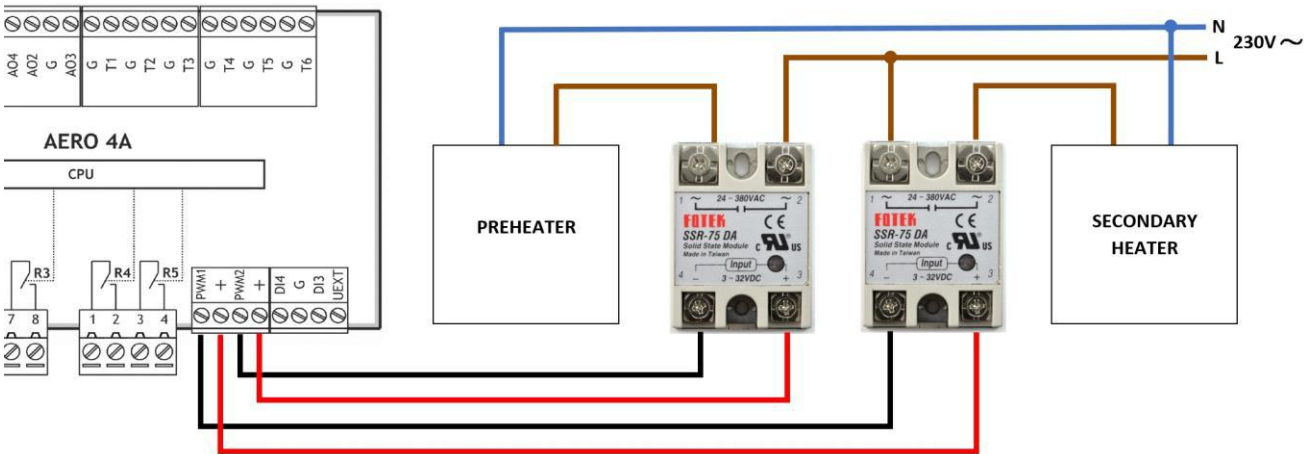

CAUTION!



The reheater power supply should be from an external source (do not use connectors inside the air handling unit). The reheater should be installed in the ventilation duct outside the unit.

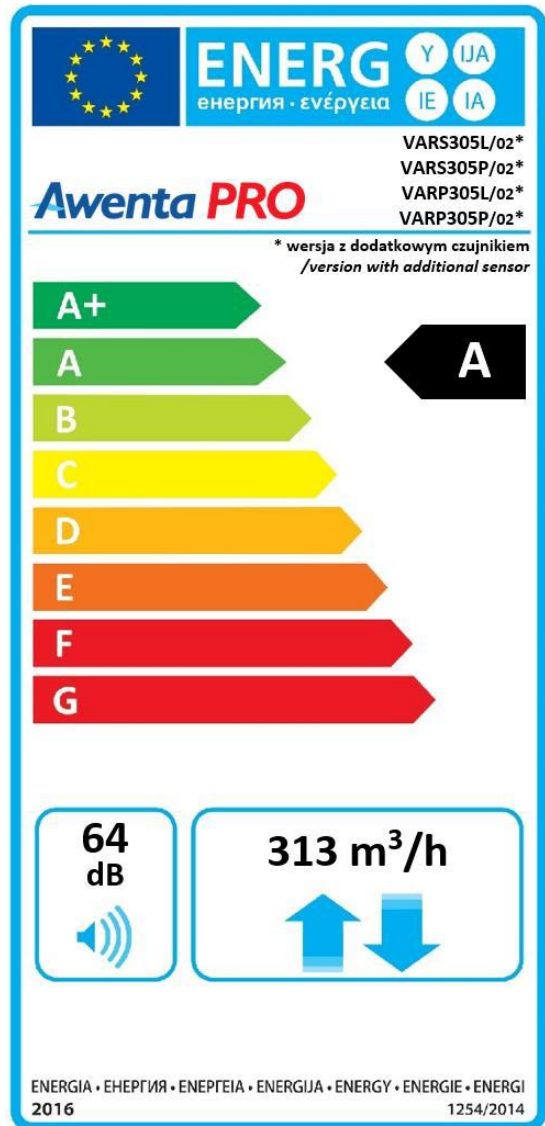
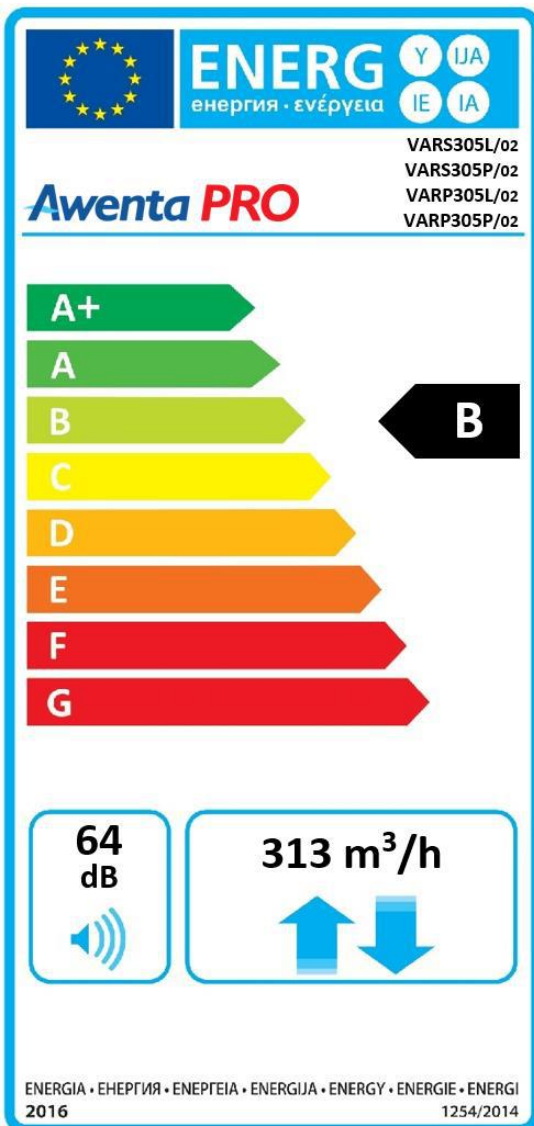

Dane energetyczne wg załącznika IV ROZPORZĄDZENIA KOMISJI (UE) NR 1254/2014
 Energy data according to IV COMMISSION REGULATION (EU) No 1254/2014

Nazwa dostawcy / <i>Supplier's name</i>	AWENTA E.W.A. Chomka Spółka Jawna 05-300 Mińsk Mazowiecki Stojadła ul. Warszawska 99
Identyfikator modelu producenta / <i>Supplier's model identifier</i>	VAR305L/02, VAR305P/02, VARP305L/02, VARP305P/02

Jednostkowe Zużycie Energii JZE / klasa [kWh/m ² /rok] / <i>Specific Energy Consumption class SEC / class [kWh/m²/yr]</i>			
Rodzaj sterowania <i>Type of control</i>	Klimat / <i>Climate</i>		
	Chłodny / <i>Cold</i>	Umiarkowany / <i>Temperate</i>	Ciepły / <i>Warm</i>
Centralne sterowanie według zapotrzebowania* <i>Central control by demand*</i>	-68,6 / A+	-32,7 / B	-9,5 / F
Lokalne sterowanie według zapotrzebowania** <i>Local control by demand**</i>	-75,5 / A+	-38,2 / A	-14,3 / E

Deklarowany typ / <i>Declared type</i>	SWM dwukierunkowy / <i>UVR bidirectional</i>
Rodzaj napędu / <i>Type of drive</i>	Bezstopniowy / <i>Stepless</i>
Rodzaj układu odzysku ciepła / <i>Type of heat recovery system</i>	Przeponowy / <i>Membranous</i>
Sprawność cieplna odzysku ciepła / <i>Thermal efficiency of heat recovery at reference air flow</i>	78,5 %
Maksymalna wartość natężenia przepływu / <i>Maximum flow rate</i>	313 [m ³ /h]
Pobór mocy napędu wentylatora, w tym wszystkich układów sterowania silnika, przy maksymalnym natężeniu przepływu <i>Electric power input of the fan drive, including any motor control equipment, at maximum flow rate</i>	210 W
Poziom mocy akustycznej (L _{WA}), (przy maksymalnej wydajności) <i>Sound power level (L_{WA}), (at maximum air flow)</i>	64 dB(A)
Wartość odniesienia natężenia przepływu / <i>Reference flow rate</i>	0,061 m ³ /s
Wartość odniesienia różnicy ciśnienia / <i>Reference pressure difference</i>	50 Pa
Jednostkowy pobór mocy JPM / <i>Specific Power Input SPI</i>	0,44 W/(m ³ /h)
Czynnik rodzaju sterowania / <i>Control factor</i>	0,85 * 0,65 **
Rodzaj sterowania / <i>Control typology</i>	Centralne sterowanie według zapotrzebowania* / <i>Central control by demand*</i> Lokalne sterowanie według zapotrzebowania** / <i>Local control by demand**</i>
Deklarowany współczynnik maksymalnych wewnętrznych przecieków powietrza MISC / <i>Maximum internal leakage rates MISC</i>	1,62 %
Deklarowany współczynnik maksymalnych zewnętrznych przecieków powietrza MISC / <i>Maximum external leakage rates MISC</i>	1,11 %
Stopień mieszania / <i>Mixing rate</i>	Nie dotyczy / <i>Not applicable</i>
Umieszczenie i opis mechanizmu wizualnego ostrzeżenia o konieczności wymiany filtra / <i>Position and description of visual filter warning</i>	Ostrzeżenie na wyświetlaczu urządzenia / <i>Warning on the device display</i>
Adres strony internetowej / <i>Internet address</i>	www.awentapro.pl
Podatność przepływu powietrza na zmiany ciśnienia +20Pa i -20Pa <i>Airflow sensitivity to pressure variations at +20Pa and -20Pa</i>	Nie dotyczy / <i>Not applicable</i>
Szczelność między wnętrzem i obszarem na zewnątrz budynku / <i>Indoor / outdoor air tightness</i>	Nie dotyczy / <i>Not applicable</i>

Roczne zużycie energii RZE [kWh/rok] / <i>Annual Energy Consumption [kWh/yr]</i> Roczna oszczędność w ogrzewaniu ROO [kWh/rok] / <i>Annual heating saving [kWh/yr]</i>						
Rodzaj sterowania <i>Type of control</i>	Klimat / <i>Climate</i>					
	Chłodny / <i>Cold</i>		Umiarkowany / <i>Temperate</i>		Ciepły / <i>Warm</i>	
	RZE	ROO	RZE	ROO	RZE	ROO
Centralne sterowanie według zapotrzebowania* <i>Central control by demand*</i>	982,9	8447,8	445,9	4318,3	400,9	1952,7
Lokalne sterowanie według zapotrzebowania** <i>Local control by demand**</i>	816,4	8715,7	279,4	4455,3	234,4	2014,6

* wyposażenie standardowe z panelem NANO COLOR 2 / *standard equipment with NANO COLOR 2 panel*

** wyposażenie opcjonalne z dodatkowym czujnikiem CO₂ lub czujnikiem wilgotności / *optional equipment with additional CO₂ or humidity sensor*



Producent:

AWENTA Spółka Jawna

05-300 Mińsk Mazowiecki, Stojadła, ul. Warszawska 99, Poland

tel: +48 25 758 52 52, +48 25 758 93 92 / fax: +48 25 758 14 62

e-mail: info@awentapro.pl

www.awentapro.pl